



Federal Ministry  
of the Interior, Building  
and Community



Federal Institute for  
Research on Building,  
Urban Affairs and  
Spatial Development

within the Federal Office for  
Building and Regional Planning



# 5 Years of Educational Buildings

conformant with the Efficiency House Plus Standard



Insights from the  
Accompanying Research





# Five Years of Educational Buildings conformant with the Efficiency House Plus Standard

Insights from the Accompanying Research

## Publication information

### Published by

Federal Institute for Research on Building, Urban Affairs and Spatial Development  
within the Federal Office for Building and Regional Planning  
Deichmanns Aue 31–37  
53179 Bonn

Federal Ministry of the Interior, Building and Community  
Alt-Moabit 140  
10557 Berlin

### Project management

Federal Institute for Research on Building, Urban Affairs and Spatial Development  
Division II 2 – Energy Saving, Climate Protection  
Miriam Hohfeld  
miriam.hohfeld@bbr.bund.de

### Federal Ministry support

Federal Ministry of the Interior, Building and Community  
Division BW I 3 – Facilities Engineering and Building Services Plant  
Technical Matters in the Field of Energy and Building  
Petra Alten

### Contractor and authors

Fraunhofer Institute for Building Physics, Department of Energy Efficiency and Indoor Climate, Stuttgart  
Heike Erhorn-Kluttig  
Jessica Preuss  
Hans Erhorn

### Last updated

November 2020

### Typesetting and layout

Fraunhofer Institute for Building Physics IBP, Stuttgart  
Panatom Corporate Communication, Berlin/Rostock

### Printed by

Federal Office for Building and Regional Planning, Bonn  
Printed on recycled paper

### Orders from

effizienzhausplus@bbr.bund.de, keyword: EHP Educational Buildings

### Picture credits

See p. 65

### Reprint and copying

All rights reserved.  
Reprints are permitted only with complete citation of source.  
Please provide us with two specimen copies.

The contents of this report reflect the views of the authors and do not necessarily represent the views of the publisher.



© Schafgans DGP

## Dear readers,

The construction sector consumes huge amounts of resources – around half of all the raw materials used each year in Germany. One third of final energy consumption in Germany takes place in buildings, with heating and domestic hot water accounting for the largest shares of this figure. Until now, fossil fuels have been used to cover the vast majority of this demand, with the grey energy used – for manufacture, transport, storage and disposal, for example – not even included in the calculations. Holistic strategies are required to ensure that new builds are constructed and existing stock is renovated in a future-proof and climate-adapted manner.

The Federal Government has set itself the goal of achieving a virtually climate-neutral building stock by 2050. This goal can only be achieved if projects involving the construction of new builds or the renovation of existing stock are based on a dual strategy of improving energy efficiency and using local, renewable energy sources. For this reason, the Federal Ministry of the Interior, Building and Community and the Federal Institute for Research on Building, Urban Affairs and Spatial Development have therefore lent their backing over the past 10 years to the market launch of a new generation of buildings built to the Efficiency House Plus standard. These buildings produce more energy than they consume over the course of a year: photovoltaic (PV) modules are installed on their roofs, and storage technologies are used to improve energy use in and around them.

The first model projects were residential buildings, but since 2015 the Federal Government has also provided funding for educational buildings built to the Efficiency House Plus standard and carried out scientific evaluations of the experiences gathered. The model projects cover a broad spectrum: they include a technologically advanced faculty building at Ulm University, a research hall at Ansbach University of Applied Sciences in Feuchtwangen, two vocational school and training centres in Hockenheim and Mühl Dorf am Inn, complex measures involving new or renovated structures at upper secondary schools in Kaufbeuren and Neutraubling, and an extension at a primary school in Giebelstadt. Funding started five years ago, and a number of these model projects have already been completed. I am delighted to say that we are now able to present the first outcomes of the projects.

The Fraunhofer Institute for Building Physics (IBP) is responsible for carrying out scientific evaluations of the projects – from the planning and construction of the buildings right through to their operation. A survey carried out among the project partners reveals that integrated planning and project coordination are factors that gain in importance as the building's energy requirements increase. An energy balance is already available for one of the pilot projects (covering the year following its completion), and it shows a significant final energy surplus. Outcomes of this kind validate the Efficiency House Plus concept.

The architectural language of educational buildings and the materials and technology put to expert use in them can promote a favourable learning environment; these buildings can also serve as paradigms for the sustainable use of resources and climate protection. The projects that are presented in this brochure illustrate this on an exemplary basis.

I hope you enjoy reading this brochure and learning more about these buildings.

**Dr. Markus Eltges**

Head of the Federal Institute for Research on Building, Urban Affairs and Spatial Development



© BMI

## Dear readers,

We are all aware of the climate target for the buildings sector – a virtually climate-neutral building stock by 2050. Safe, affordable and sustainable solutions are what is needed to establish a buildings standard for the future.

The Federal Ministry of the Interior, Building and Community believes in carrying out research of its own when it comes to construction-related matters. The Efficiency House Plus research initiative and the model projects built to the Efficiency House Plus standard showcase successful solutions that allow the construction process to be conceived in a more innovative and climate-friendly manner.

Efficiency House Plus buildings mark the dawn of an era of positive energy balances for buildings, and serve as examples proving that climate protection and construction can be successfully combined without compromising on quality of life or the nature of the built environment. The potential of Efficiency House Plus buildings can also be leveraged on a broader scale in residential areas or within larger complexes, since their positive energy balances mean that they can also supply energy to adjacent buildings.

This future-proof building standard has been trialled in non-residential buildings since 2015, and scientific research is currently being carried out on a total of seven model projects under the “Efficiency House Plus – Educational Buildings” research programme. These buildings are intended to set new benchmarks for the construction of school facilities and provide a good example of what can be done. After all, where better to acquaint the future generation with this forward-looking building standard than in schools?

It is not only building owners and users that have come to appreciate the high quality of the Efficiency House Plus model projects; their reputation has spread far and wide. In 2019, the first Efficiency House Plus school that was completed – the Louise Otto-Peters School in Hockenheim – was awarded a prize for “Exemplary Construction” by the Chamber of Architects of Baden-Wuerttemberg.

This brochure examines and compares the school projects financed under the Efficiency House Plus initiative with funds from the “Future Building” innovation programme. The descriptions of the different methodologies that were followed for these projects are intended to serve as a source of guidance and inspiration. The Federal Ministry of the Interior, Building and Community, together with the Federal Institute for Research on Building, Urban Affairs and Spatial Development and the Fraunhofer Institute for Building Physics (IBP), is delighted to support and further advance this new generation of climate-friendly buildings.

### **Secretary of State Christine Hammann**

Head of the Directorate-General

for Building, Construction Industry and Federal Buildings

Federal Ministry of the Interior, Building and Community

## Table of contents

Introduction .....	8
Definition: Efficiency House Plus .....	9
Model projects	
Louise Otto-Peters School in Hockenheim .....	10
Neutraubling Upper Secondary School .....	16
Vocational school centre in Mühldorf am Inn .....	22
Jakob Brucker Upper Secondary School in Kaufbeuren .....	28
Research hall at Ansbach University of Applied Sciences in Feuchtwangen .....	34
Extension at Giebelstadt Primary School .....	40
Replacement building at Ulm University .....	46
Cross-evaluation of planning .....	52
Motives .....	58
Lessons learned .....	59
Evaluation of initial monitoring data .....	60
List of abbreviations .....	64
Units .....	64
Important links .....	64
Publications .....	65
List of figures and picture credits .....	65

## Introduction

### Efficiency House Plus: an initiative of the Federal Government

Germany has a long history of energy-saving construction, and its intensive research and development efforts in connection with the Efficiency House Plus standard have been so successful that the buildings built to this standard produce more energy than they use. To put it another way, the energy generated locally from renewable sources by an Efficiency House Plus building over the course of a year exceeds the energy consumed by the building and its users.

An Efficiency House Plus building is not tied to any particular technology. Instead, it can be implemented in a variety of different ways, using a smart combination of energy-efficient construction technologies, building services and renewable energy recovery systems, which makes it a technology-neutral strategy. The Efficiency House Plus approach serves as an ideal foundation for meeting Germany's climate protection target of a virtually climate-neutral building stock by 2050. Unlike conventional buildings, each Efficiency House Plus building that is completed reduces both fossil fuel consumption and greenhouse gas emissions in Germany, and acts as a carbon sink on our country's climate balance sheet.

Since 2011, the Efficiency House Plus standard has been able to demonstrate its practical viability within the framework of research funding programmes operated by the Federal Ministry of the Interior, Building and Community. The 36 residential buildings that were granted funding have now been completed and their outcomes evaluated. In the case of the seven model projects that were funded in the educational buildings sector, construction has either commenced or will shortly commence; others are part-way through the 24-month monitoring period of normal operation that follows completion.

All of the buildings are tested and evaluated under real-life conditions by a number of different research establishments as part of an intensive monitoring programme, and all the results are also cross-evaluated by the Fraunhofer Institute for Building Physics (IBP). Key performance data such as consumption of heating energy, consumption and generation of electricity, own use of renewable energy, primary energy consumption and comfort parameters are recorded and assessed. In addition to a cross-comparison of all projects in respect of the key performance data and compliance with the Efficiency House Plus standard in practical tests, the variables used to calculate the electricity consumption associated with lighting or with specialist/domestic appliances and processes are validated on an ongoing basis. Selected model projects are also assessed in an accompanying social science research programme. It is intended that the outcomes will be used to improve energy management in modern buildings and further develop the components required for energy-efficient building envelopes and the use of renewable energies.

This brochure was produced as part of the research that accompanied the research initiative, and focuses on the topic of education-



Figure 1: Overview map showing the location of the seven model projects involving Efficiency House Plus educational buildings in Germany  
Source: Fraunhofer IBP

nal buildings. As well as describing the relevant concepts, specific details of the buildings' structures and systems engineering, and the energy balances for the individual projects, it compares certain parameters and compiles them into benchmarks in order to make it easier to appraise the practical impact of these new approaches and concepts. In addition, the lessons learned from the planning and construction phases are compiled and guidance issued with a view to avoiding potential problems.



## Definition: Efficiency House Plus

The Efficiency House Plus standard is deemed to have been achieved if the building displays both a negative annual primary energy demand ( $\sum Q_p < 0$  kWh per square metre per year) and a negative annual final energy demand ( $\sum Q_e < 0$  kWh per square metre per year). All the remaining requirements imposed by the Buildings Energy Act (*Gebäudeenergiegesetz*, GEG) must also be met, for example those relating to overheating protection in summer.

### Evaluation method: expanded evidence of compliance based on the Buildings Energy Act in accordance with DIN V 18599

In keeping with the Buildings Energy Act, evidence of compliance must be provided in accordance with DIN V 18599. The total electricity infeed is to be assessed equally to the displacement mix. According to the Buildings Energy Act, the reference climate for Germany (reference location Potsdam) must be used when proving compliance. However, in addition to the certification procedure according

to the Buildings Energy Act, the calculations must also take into account the final and primary energy demand for electrical equipment. An overall annual final energy demand of 20 kilowatt hours per square metre of heated net floor area per year is used for residential buildings. For educational buildings 10 or 15 kilowatt hours per square metre of heated net floor area per year is assumed, depending on the energy efficiency of the appliances used.

### Boundary of the performance assessment: plot perimeter

The boundaries used in the performance assessment (also to include renewable energy facilities) are the boundaries of the building plot. In addition to the area used according to the Buildings Energy Act (which requires a direct spatial link to the building), the sum of all the energy generated from renewable sources within the building plot ("on-site generation") can be taken into account. The plot perimeter is the boundary of the property assigned to the building as entered in the land registry. If there are several buildings on a single plot, the amount of renewable energy generated on site is assigned proportionally to the individual buildings based on the floor areas of these buildings.

### Additional information required on the certificate:

#### the self-used proportion of renewable energy generated on site

The ratio of self-used renewable energy generated on site to energy generated within the balance boundary must be documented in addition to the annual primary energy demand and annual final energy demand. The calculations must be made in accordance with the Buildings Energy Act assessment based on monthly balances.

### Calculation tool and energy performance certificate

The standardised calculations for an Efficiency House Plus can be carried out using a free online tool ([www.effizienzhaus-plus-rechner.de](http://www.effizienzhaus-plus-rechner.de)). The tool also allows the generation of an additional information sheet specifically developed for the Efficiency House Plus, both for housing and non-residential buildings, which represent the savings effect of the generation of these buildings that goes beyond the Buildings Energy Act.

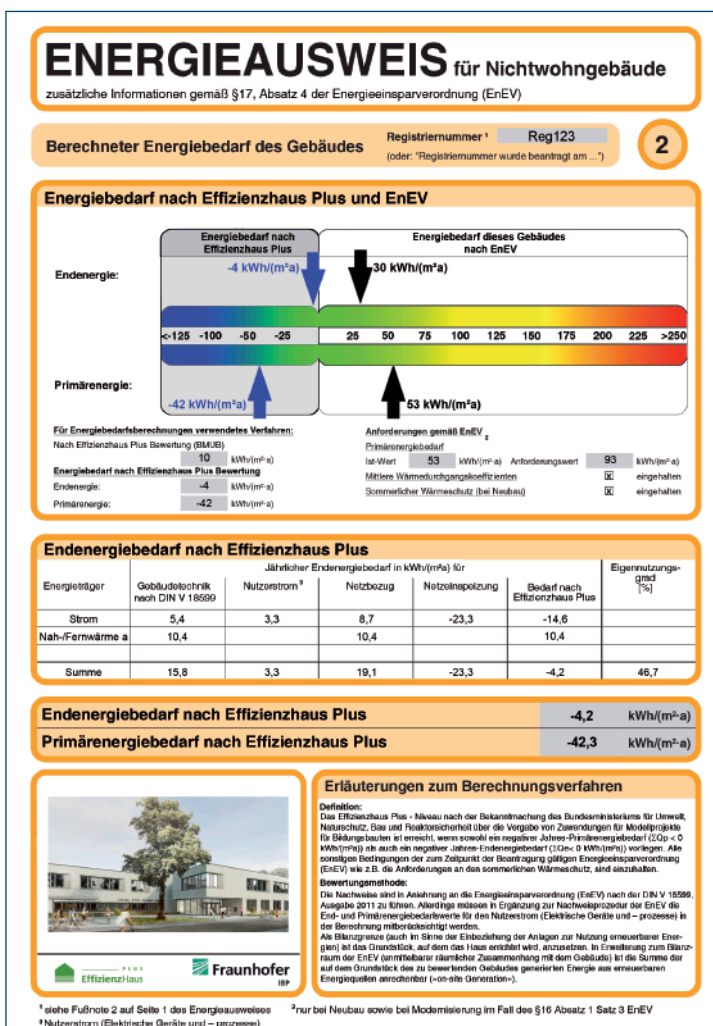

Figure 2: Factsheet to supplement energy certificates for buildings built to the Efficiency House Plus standard (can be generated using the online tool)  
Source: Fraunhofer IBP

# Louise Otto-Peters School in Hockenheim

According to calculations, the building's energy surplus will save 19 tonnes of CO<sub>2</sub> per year.



Figure 3: The assembly hall on the ground floor with a view to the top floor through the open space.  
Photograph: Rhine-Neckar District



# Model project

## Louise Otto-Peters School in Hockenheim



Figure 4: Entrance area on the south-west side of the school  
Photograph: Dorothea Burkhardt

### General data

Table 1: Selection of general information on the building and the project participants

Location	Schubertstraße 11, 68766 Hockenheim
Year of construction	2016–2017
Building owner	Municipal Enterprise for Construction and Assets ( <i>Eigenbetrieb Bau und Vermögen</i> ) Rhine-Neckar District
Architect	Roth.Architekten.GmbH, Schwetzingen
Monitoring	ina Planungsgesellschaft mbH, Darmstadt
Technical building services	Ingenieurbüro Willhaug GmbH, Mosbach; BF Controls Ltd., Schwabach; Beck Elektroanlagen GmbH, Helmstadt-Bargen

Table 2: Selection of building parameters

Gross floor area	4,190 m <sup>2</sup>
Heated net floor area	3,766 m <sup>2</sup>
Heated building volume	15,787 m <sup>3</sup>
Building envelope factor A/V	0.38 m <sup>-1</sup>
Number of classrooms/ special subject rooms/ common rooms	20
Total area of teaching rooms	1,307 m <sup>2</sup>

### Project description

The Louise Otto-Peters school in Hockenheim was the first educational institution to be granted support under the “Efficiency House Plus – Educational Buildings” funding programme operated by the Federal Ministry of the Interior, Building and Community. This newly constructed climate-neutral building of the future combines three different school types under one roof (a pre-vocational training programme, a vocational upper secondary school and a geriatric nurse/educator training programme) which are attended by up to 280 students in total.

The bright and friendly building is ultra-modern in terms of its energy use, and was constructed on a 5,000-m<sup>2</sup> plot that used to house the former St. Josef Catholic kindergarten and is located opposite the previous school. The building not only complies with the climate protection guidelines laid down by the Rhine-Neckar District, but goes far beyond what is required by law.

The newly constructed building is designed in such a way that it can be operated as efficiently as possible from both a financial and an ecological perspective, and is intended to save up to 19 tonnes of CO<sub>2</sub> per year.

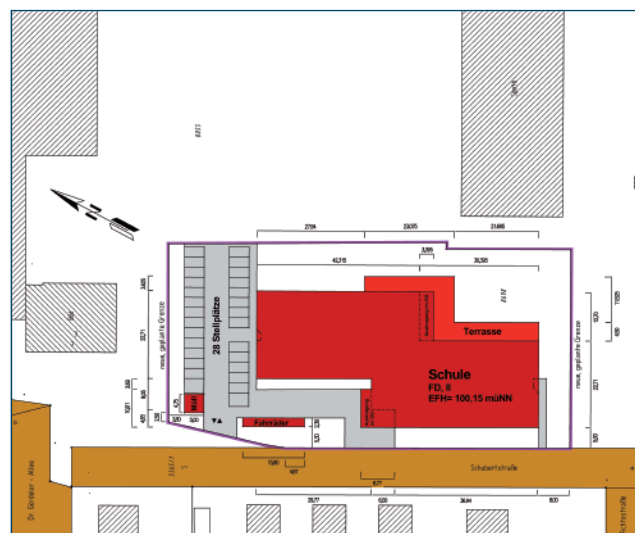

Figure 5: Site plan of the entire complex  
Plan: Roth.Architekten.GmbH

### Architecture

The school building has a clear structure, with two wings accessible from a central foyer area on each level. The entire administration department and a large staffroom are situated on the ground floor of the north-east wing. All of the vocational/technical classrooms are located in the south-west wing. The top floor of each wing contains four classrooms interspersed with general science

classrooms, several pupil workspaces for groups of different sizes and the pupil library. The central foyer, which forms the heart of the building and is also used as an assembly hall, is connected to the top floor through an open space. The assembly hall can be combined with the student common room for larger gatherings and school events, and also with the eurhythmics room if necessary.



Figure 6: Ground floor plan of the school building  
 Plan: Roth.Architekten.GmbH



Figure 7: A classroom  
 Photograph: Dorothea Burkhardt



Figure 8: Open space linking the assembly hall and the gallery on the top floor  
 Photograph: Dorothea Burkhardt



Figure 9: The kitchen classroom  
 Photograph: Rhine-Neckar District

### Components

The solid external walls feature a 20-cm layer of thermal insulation, overlaid with adhered brick veneers in certain parts and a rear-ventilated metal façade in others. The windows were designed as wood/aluminium windows with triple thermal insulation glazing. The flat roof is constructed from solid reinforced concrete and a layer of tapered insulation measuring on average 30 cm in thickness, with waterproofing and gravel cover on top. The floor slab has a thickness of 25 cm and rests on top of pressure-resistant perimeter insulation with a thickness of 20 cm. The flooring is installed on a floating screed with an insulating layer measuring 8 to 9 cm in thickness.

Table 3: List of U-values for the building envelope components

Component	U-value [WW per m <sup>2</sup> per Kelvin]
External wall	0.16–0.18
Windows	0.80
Roof	0.13
Floor slab	0.13–0.14

## Systems engineering

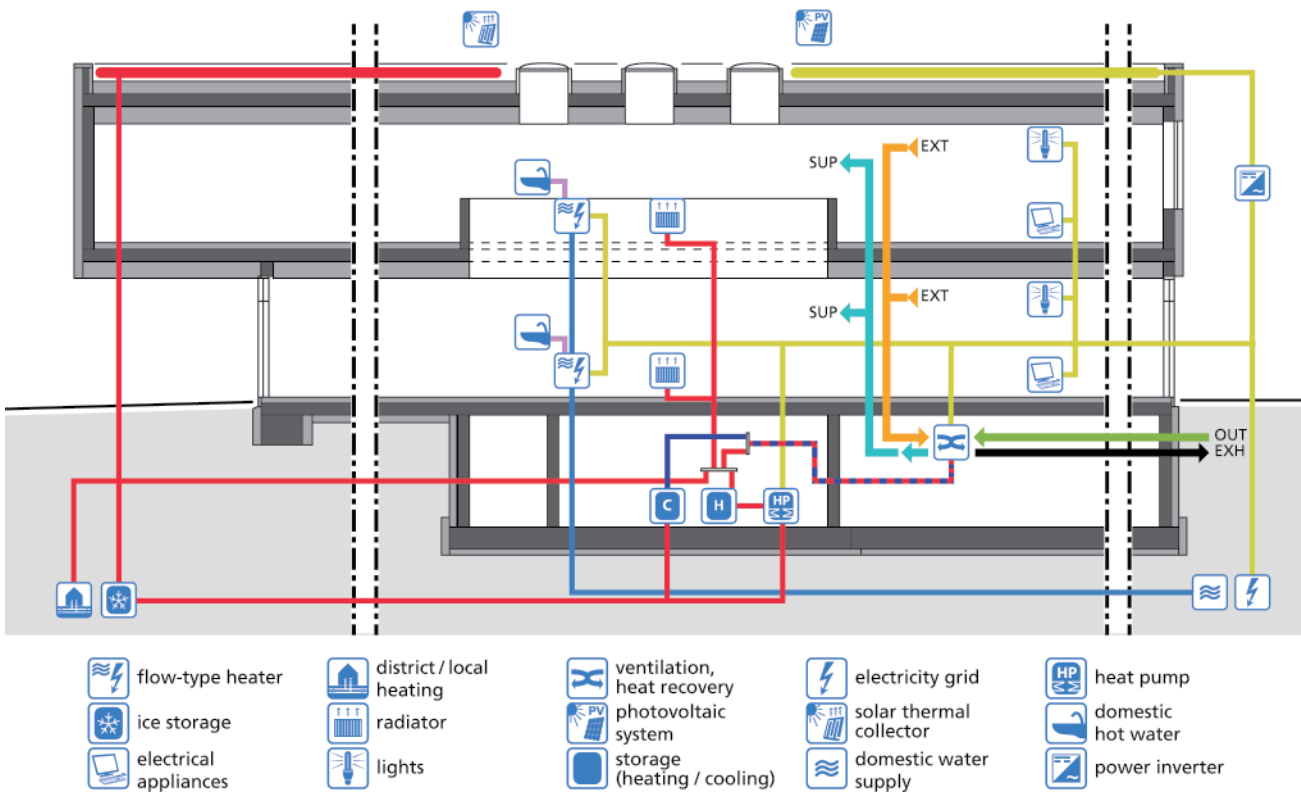

Figure 10: Longitudinal cross-section through the building and design of the building services  
Diagram: Fraunhofer IBP



Figure 11: The ice storage unit during construction  
Photograph: Ingenieurbüro Willhaug Gebäude-  
technik GmbH



Figure 12: The photovoltaic system  
Photograph: Rhine-Neckar District



Figure 13: The solar thermal collectors  
Photograph: Ingenieurbüro Willhaug Gebäude-  
technik GmbH

The building is supplied with heat by a 29-kW brine-water heat pump. The heat sources used in this connection include an ice storage unit buried in the ground with a water volume of 82 m<sup>3</sup>, and 14 solar absorber collectors installed on the roof with a total area of 40 m<sup>2</sup> and a heat extraction rate of 27,720 kWh per year. At peak load times, heat is also supplied via the municipal district/local heating network. Around 10% of the heat is transferred via radiators, and 90% via the ventilation system through air outlets in the ceiling or in split-level ceiling. In addition, the fresh air in the central ventilation unit is thermally treated in the preheater and reheat coil before it is delivered to the classrooms through a two-channel system at different temperatures. Room-by-room temperature control is achieved by means of volumetric flow controllers in the suspended ceilings. The use of a heat pump in combination with ice storage technology is intended to guarantee energy-efficient operation that can also be

used for “passive” cooling during the summer months. The central mechanical ventilation system boasts a heat recovery rate of over 80%, which minimises the amount of heat lost in winter and increases indoor air comfort. Distributed volumetric flow controllers in the ceiling allow individual adjustments to be made to indoor air quality, and natural ventilation is possible through the windows. Electric flow-type heaters are used to heat domestic hot water on a distributed basis in selected rooms. A photovoltaic system covering an area of 1,048 m<sup>2</sup> and consisting of 639 modules with monocrystalline solar cells is installed on the roof, with an output of 191.4 kW<sub>p</sub>. A total of 320 modules face north-east, and 319 face south-west.

## Energy

According to calculations, the building requires 148,898 kWh of final energy per year (39.5 kWh per m<sup>2</sup><sub>heatedNFA</sub> per year) in the form of electricity and district heating from the municipal grid. Of this figure, more than half (62%) is used to operate building services systems; electrical equipment (25%) and lighting (13%) play a secondary role in this respect. According to a PV simulation at the climate reference location of Potsdam, the PV system on the school's

roof generates 164,748 kWh of renewable energy per year, resulting in an anticipated annual surplus of 15,850 kWh per year in the final energy balance. It is expected that 47% of the electricity generated locally by the PV system will be used in the building itself, and that 53% will be fed into the grid. In terms of primary energy calculations, the balance surplus is forecast to be 159,425 kWh per year.

## Final energy

Table 4: Final energy demand

Component	Energy demand	
	[kWh per year]	[kWh per square metre per year] <sup>1)</sup>
Heating (CHP, local district heating)	39,220	10.4
Heating/domestic hot water (electricity)	24,309	6.5
Cooling (electricity)	1,584	0.4
Auxiliary energy for heating, domestic hot water, ventilation (electricity)	27,144	7.2
Lighting (electricity)	18,981	5.0
Electrical equipment	37,660	10.0
<sup>1)</sup> related to heated net floor area of 3,766 m <sup>2</sup>		
<b>Total</b>	<b>148,898 kWh per year</b>	

Table 5: Final energy coverage

Component	Energy yield	
	[kWh per year]	[kWh per square metre per year] <sup>2)</sup>
PV system on roof	164,748 <sup>3)</sup> (111,881) <sup>4)</sup>	157.2 (107.0)
<sup>2)</sup> related to PV module area on roof of 1,048 m <sup>2</sup>		
<sup>3)</sup> according to PV simulation with the location Potsdam		
<sup>4)</sup> according to DIN V 18599 (2011) with standard values and reference climate Potsdam		
<b>Total</b>	<b>164,748 kWh per year</b>	

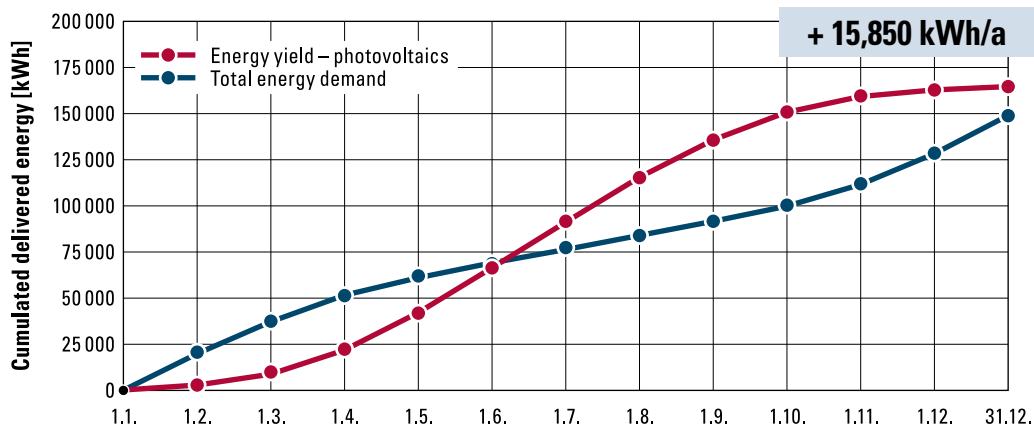

Figure 14: Predicted final energy surplus, Chart: Fraunhofer IBP

## Primary energy

Table 6: Primary energy supply from external sources

Component	Primary energy demand for each needed energy source	
	[kWh per year] <sup>5)</sup>	[kWh per square metre per year] <sup>1)</sup>
Local district heating	27,453	7.3
Electricity demand (HVAC + lighting)	36,346	9.7
Demand for electrical equipment according to the Efficiency House Plus standard	22,482	6.0
<sup>1)</sup> related to heated net floor area of 3,766 m <sup>2</sup>		
<sup>5)</sup> 47% of the PV energy yield is used by the building itself and thus reduces the energy needed from the grid		
<b>Total</b>	<b>86,281 kWh per year</b>	

Table 7: Primary energy credit due to grid feed-in

Component	Electricity surplus	
	[kWh per year] <sup>6)</sup>	[kWh per square metre per year] <sup>2)</sup>
PV system on roof	245,706	234.5
<sup>2)</sup> related to PV module area on roof of 1,048 m <sup>2</sup>		
<sup>6)</sup> 53% of the PV energy yield is fed into the grid		
<b>Total</b>	<b>245,706 kWh per year</b>	

[status of energy parameters: April 2016]

# Neutraubling Upper Secondary School

The predicted amount of CO<sub>2</sub> saved due to the energy surplus of the newly constructed and renovated buildings is equivalent to the annual carbon sink of 19 hectares of forest.\*

\*) corresponds to 20 t CO<sub>2</sub> per year



Figure 15: View into the staffroom  
Photograph: Winkler-Architekten





## Model project

### Neutraubling Upper Secondary School

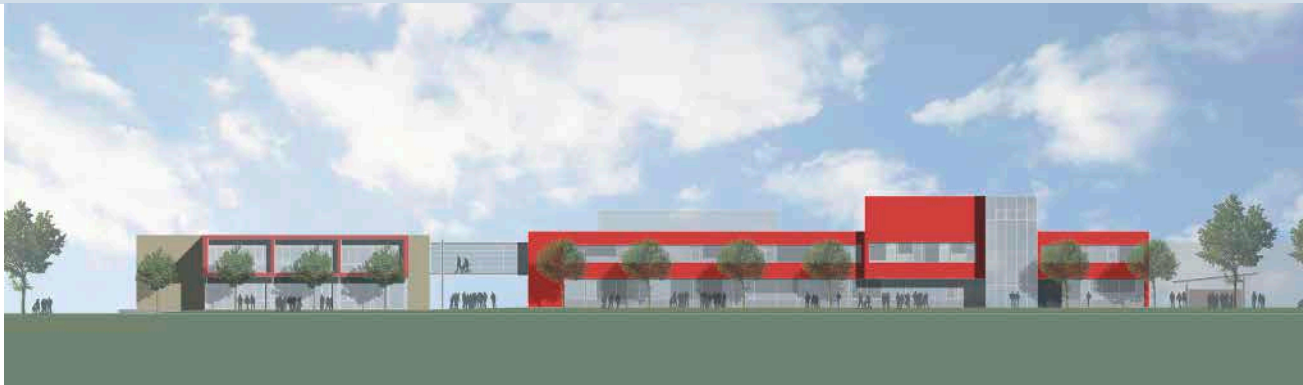

Figure 16: The entire complex viewed from the south  
Visualisation: Winkler-Architekten

#### General data

Table 8: Selection of general information on the building and the project participants

Location	Gregor-Mendel-Straße 5, 93073 Neutraubling
Year of construction	Construction segment 1: new build 2017–2018; Construction segments 2 and 3: renovation 2020–2021
Building owner	Rural District of Regensburg
Architect	Winkler-Architekten (architecture office), Wörth an der Donau
Monitoring	Dresden University of Technology, Institute of Power Engineering ( <i>Institut für Energietechnik</i> , IET); EA Systems Dresden GmbH
Technical building equipment	Scholz GmbH & Co. KG (engineering office), Regensburg

Table 9: Selection of building parameters

Gross floor area	12,830 m <sup>2</sup>
Heated net floor area	10,338 m <sup>2</sup>
Heated building volume	45,510 m <sup>3</sup>
Building envelope factor A/V	0.33–0.38 m <sup>-1</sup>
Number of classrooms/ special subject rooms/ common rooms	67
Total area of teaching rooms	3,970 m <sup>2</sup>

#### Project description

Neutraubling Upper Secondary School was built in 1974 and has been extended on several occasions. Prior to the project start date, the school building comprised three interconnected parts: a cafeteria, a triple-court sports hall with classroom wing and a single-court sports hall.

Construction segment 1 involved building a new structure with 12 classrooms, a staffroom, a library, an all-day school (*Ganztagschule*) area and an administration area. Following completion of the new build, the next stage will involve renovating the remainder of the building complex. During construction segment 2 – which will follow the demolition of part of the building – a central wing with an entrance area, 28 classrooms and an assembly hall will be constructed, and the parts of the building that are not demolished will be renovated. During construction segment 3, nine classrooms and the biology department will be renovated. Installation of a ventilation system with heat recovery is planned for the cafeteria.

The space within the upper secondary school will be restructured and enhanced, and the building will undergo an energy upgrade. The chemistry classrooms and preparation rooms will also be brought into line with the current state of the art. The upper secondary school's new extension and the renovated areas of its existing

buildings (construction segments 1 to 3) will be executed in accordance with the Efficiency House Plus standard.



Figure 17: Site plan of the entire complex  
Plan: Winkler-Architekten

### Architecture

The new build comprises a two-storey cross-wing to the south of the school grounds, running parallel to the adjacent road. The rooms accommodating the all-day school are located on the ground floor of this building, while the school's entire administration area, including the staffroom and library, are clustered together on the top floor. The new build has a separate entrance on the street side and a connecting corridor to the neighbouring cafeteria building on the east side.

Construction segment 2 will involve the renovation of the three-storey central block, with an open staircase and a through open space.

The building is directly adjacent to the new build, and all three of its floors are taken up mainly by classrooms used for different purposes. Following the partial demolition of the building, a new annex will also be added on the eastern side of the central block, with an extended assembly hall area, a vestibule and a window for dispensing break-time snacks. New covered break-time areas have been constructed on the north and south-west sides of the inner courtyard. Once the works under construction segment 2 have been completed, construction segment 3 will commence, involving the renovation and energy upgrading of a structure on the west of the school grounds.

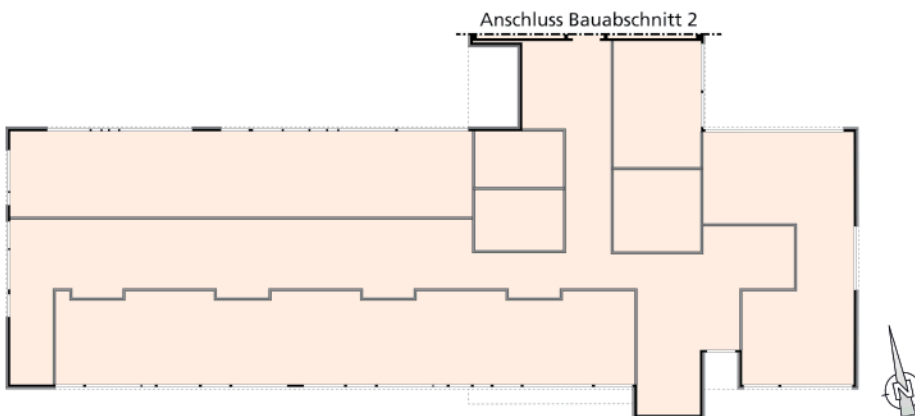

Figure 18: Outline plan of the new build's ground floor, construction segment 1  
Plan: Winkler-Architekten



Figure 19: Partial view of the building's south side  
Photograph: Winkler-Architekten



Figure 20: Entrance to a teaching room with a seating alcove  
Photograph: Winkler-Architekten



Figure 21: Break room and kitchenette  
Photograph: Neutraubling Upper Secondary School

### Components

The solid external walls of the new build feature a 26-cm layer of thermal insulation covered with a 1-cm layer of plaster. The classroom windows are designed as wood/aluminium windows with triple thermal insulation glazing. The stairwells have an aluminium post-and-beam façade together with daylight-diverting solar control glazing. The flat roof is constructed from solid reinforced concrete with a layer of tapered insulation measuring on average 23 cm in thickness, overlaid by waterproofing and gravel cover. The floor slab has a thickness of 20 cm and rests on top of pressure-resistant perimeter insulation with a thickness of 16 cm. The surface covering of the floor is installed on a floating screed with an insulating layer measuring 9 cm in thickness.

The components in construction segments 2 and 3 will be thermally optimised and the windows replaced during the renovation.

Table 10: List of U-values for the building envelope components

Component	U-value [WW per m <sup>2</sup> per Kelvin]	
	New build, construction segment 1	Renovation, construction segments 2 and 3
External wall	0.16	0.15
Windows	0.76	0.90
Façade	0.80	0.80
Roof	0.11	0.11
Floor slab	0.15	0.52

Systems engineering

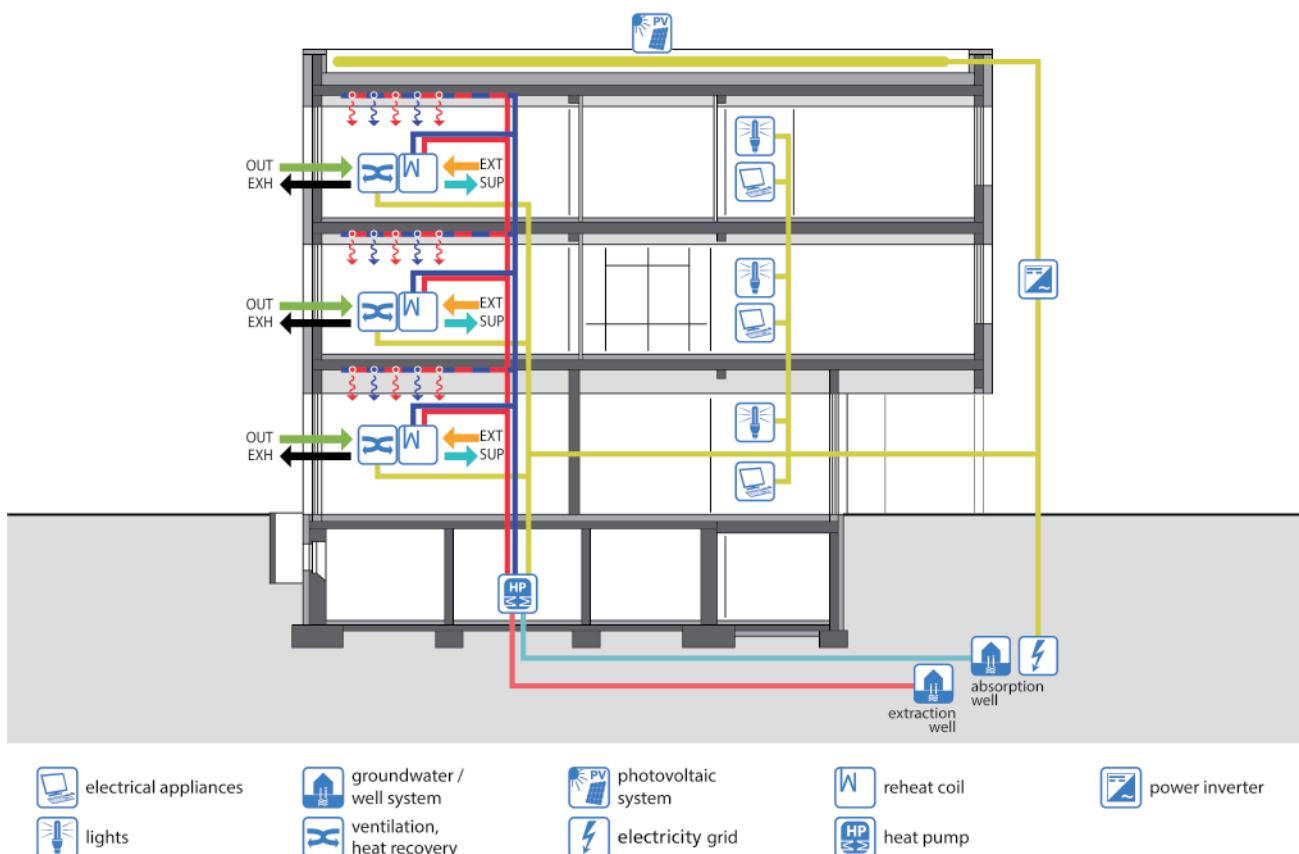

Figure 22: Longitudinal cross-section through the building and design of the building services  
Diagram: Fraunhofer IBP



Figure 23: PV system on the roof of the new build  
Photograph: Neutraubling Upper Secondary School

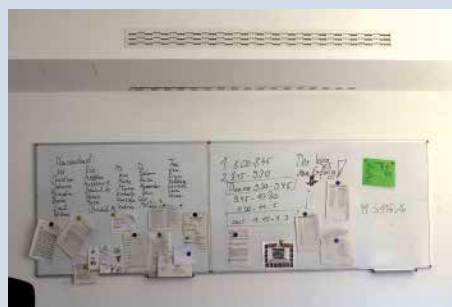

Figure 24: Ceiling diffusers of the ventilation system  
Photograph: Neutraubling Upper Secondary School



Figure 25: View into the plant room  
Photograph: Neutraubling Upper Secondary School

Reversible water-water heat pumps will be installed to supply heating and cooling to construction segments 1 to 3 (2 x 50 kW + 1 x 70 kW). The heat pumps use groundwater from the well system as a source of energy and supply the heated and chilled ceilings and the reheat coils in the decentralised ventilation systems.

Active cooling using a heat pump takes place in the server room and the IT room. The classrooms are passively cooled, i.e. groundwater is routed directly into the cooling circuit via a heat exchanger without any assistance from the heat pump.

The individual ventilation units in the classrooms are linked to the heated and chilled ceilings, meaning that the room temperature can be regulated using the ventilation unit controls. The supply of energy via the ventilation device and the panel heaters can be

controlled on a room-by-room basis, which eliminates the need for expensive higher-level instrumentation and control systems.

A PV system made from polycrystalline silicon cells, covering an area of 585 m<sup>2</sup> and with an output of 94.3 kW<sub>p</sub>, is installed on the roof of the new build. A PV system covering an area of 800 m<sup>2</sup> and with an output of 131.7 kW<sub>p</sub> is installed on the roofs of construction segments 2 and 3. The PV systems are supplemented by an existing system on the roof of the triple-court gymnasium, which covers an area of around 1,023 m<sup>2</sup> and delivers an output of 127 kW<sub>p</sub>.

## Energy

According to the calculations, the parts of the buildings that comply with the Efficiency House Plus standard require 269,786 kWh of electricity per year (26 kWh per m<sup>2</sup><sub>heated NFA</sub> per year). Of this figure, around half (46%) is used to operate building services systems; electrical equipment (39%) and lighting (16%) play a secondary role in this respect. Under average climatic conditions, the PV system on the roof of the school complex will generate 306,401 kWh of re-

newable energy per year; the resulting annual surplus in the final energy balance is anticipated to be 36,615 kWh per year. It is expected that 55% of the electricity generated locally by the PV system will be used in the parts of the buildings built to the Efficiency House Plus standard, and that 45% will be fed into the grid or used in the other parts of the buildings. In terms of primary energy calculations, the balance surplus is forecast to be 205,099 kWh per year.

## Final energy

Table 11: Final energy demand

Component	Energy demand	
	[kWh per year]	[kWh per square metre per year] <sup>1)</sup>
Heating/domestic hot water (electricity)	66,318	6.4
Cooling (electricity)	4,062	0.4
Auxiliary energy for heating, cooling, domestic hot water, ventilation (electricity)	53,526	5.2
Lighting (electricity)	41,997	4.0
Electrical equipment	103,883	10.0
<sup>1)</sup> related to heated net floor area of 10,388 m <sup>2</sup>		
<b>Total</b>	<b>269,786 kWh per year</b>	

Table 12: Final energy coverage

Component	Energy yield	
	[kWh per year]	[kWh per square metre per year] <sup>2)</sup>
PV system on roof	306,401 <sup>3)</sup> (251,627) <sup>4)</sup>	127.5 (104.7)
<sup>2)</sup> related to PV module area on roof of 2,403 m <sup>2</sup> <sup>3)</sup> according to DIN V 18599 (2011) with nominal module power <sup>4)</sup> according to DIN V 18599 (2011) with standard values and reference climate Potsdam		
<b>Total</b>	<b>306,401 kWh per year</b>	

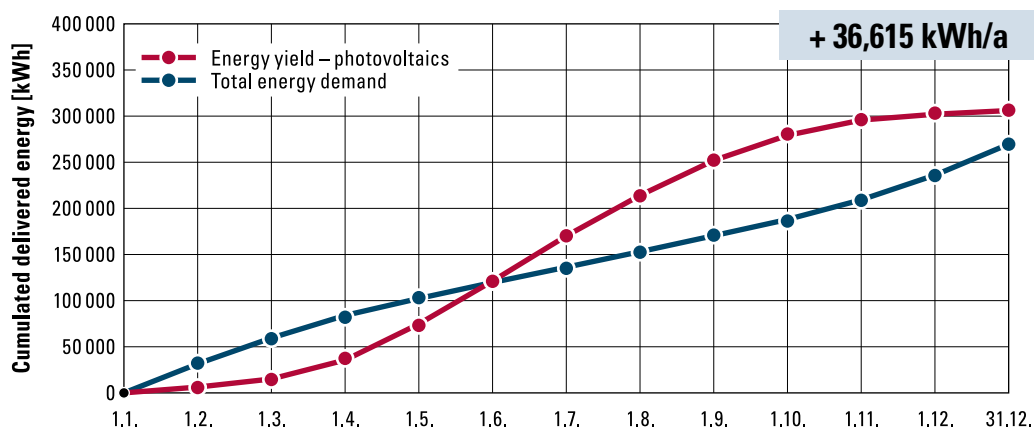

Figure 26: Predicted final energy surplus; Chart: Fraunhofer IBP

## Primary energy

Table 13: Primary energy supply from external sources

Component	Primary energy demand for each needed energy source	
	[kWh per year] <sup>5)</sup>	[kWh per square metre per year] <sup>1)</sup>
Electricity demand (HVAC + lighting)	108,103	10.4
Demand for electrical equipment according to the Efficiency House Plus standard	76,529	7.4
<sup>1)</sup> related to heated net floor area of 10,388 m <sup>2</sup> <sup>5)</sup> 55% of the PV energy yield is used by the building itself and thus reduces the energy needed from the grid		
<b>Total</b>	<b>184,633 kWh per year</b>	

Table 14: Primary energy credit due to grid feed-in

Component	Electricity surplus	
	[kWh per year] <sup>6)</sup>	[kWh per square metre per year] <sup>2)</sup>
PV system on roof	389,731	162.1
<sup>2)</sup> related to PV module area on roof of 2,403 m <sup>2</sup> <sup>6)</sup> 45% of the PV energy yield is fed into the grid		
<b>Total</b>	<b>389,731 kWh per year</b>	

# Vocational school centre in Mühldorf am Inn

The predicted positive energy balance of the vocational school compensates for the average amount of CO<sub>2</sub> emitted each year to feed 18 people in Germany.\*

\*) corresponds to 31 t CO<sub>2</sub> per year



Figure 27: The break-time area in the assembly hall  
Photograph: ARIS Architekten



## Model project

### Vocational school centre in Mühldorf am Inn



Figure 28: View from the south towards construction segment 1  
Photograph: ARIS Architekten

#### General data

Table 15: Selection of general information on the building and the project participants

Location	Innstraße 41, 84453 Mühldorf am Inn
Year of construction	2016–2020
Building owner	Rural District of Mühldorf am Inn
Architect	ARGE Schmuck-Anglhuber: Architekturbüro Schmuck, Munich; ARIS – Anglhuber und Reithmeier Partnerschaftsgesellschaft mbB, Kraiburg am Inn
Monitoring	Rosenheim Technical University of Applied Sciences
Technical building equipment	COPLAN AG, Mühldorf am Inn; Ingenieurteam Mühldorf, Mühldorf am Inn

Table 16: Selection of building parameters

Gross floor area	10,670 m <sup>2</sup>
Heated net floor area	9,596 m <sup>2</sup>
Heated building volume	38,769 m <sup>3</sup>
Building envelope factor A/V	0.29 m <sup>-1</sup>
Number of classrooms/ special subject rooms/ common rooms	SEG 1: 39 SEG 2: 25
Total area of teaching rooms	SEG 1: 2,082 m <sup>2</sup> SEG 2: 1,597 m <sup>2</sup>

#### Project description

The vocational school centre complex incorporates Public Vocational School II and four public vocational colleges with their classrooms, the associated special subject rooms, common rooms and multi-purpose rooms, a cafeteria and a student bakery.

A spacious new entrance plaza will be constructed on the campus, comprising a central circulation zone flanked on its south and east sides by a new build built to the Efficiency House Plus standard. The construction project is divided into two construction segments, and is being implemented stage by stage so that the school can continue operating without any interruptions. Construction segment 1 was put into operation before the start of the 2018/2019 school year. It is anticipated that construction segment 2 will be completed by the end of 2020.

The existing building (construction year 2001) will be left in place and integrated into the overall concept for the new build.

A two-court gymnasium is planned for the north side of the new entrance plaza and will form a structural barrier.

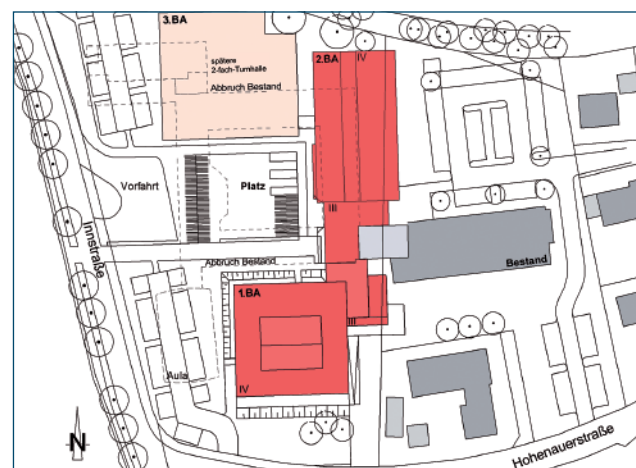

Figure 29: Site plan of the entire complex  
Plan: ARGE Schmuck-Angelhuber Architekten



### Architecture

The buildings have been designed with a straightforward and clear structure. All of the structures will be accessible on short routes originating from the central entrance plaza situated around the main stairwell of the existing building.

Construction segment 1 is organised around an internal atrium extending over all the floors, fostering an atmosphere of communication. As well as various teaching and vocational/technical rooms, this construction segment also contains the cafeteria, the canteen, the break room and the student bakery. The second construction segment will accommodate additional classrooms and special subject rooms, as well as multi-purpose rooms and the general administration rooms, which will be located centrally on the first floor.

The new build's architecture deliberately embodies a restrained but self-confident design language that is perfectly suited to the task at hand. The interplay of proportions between the substantial cuboid structure of the first construction segment, the existing wing, the second and adjacent part of the new build to the north and the future sports hall will lend a harmonious appearance to the complex as a whole.



Figure 31: The kitchen classroom  
 Photograph: ARIS Architekten



Figure 32: A classroom  
 Photograph: ARIS Architekten

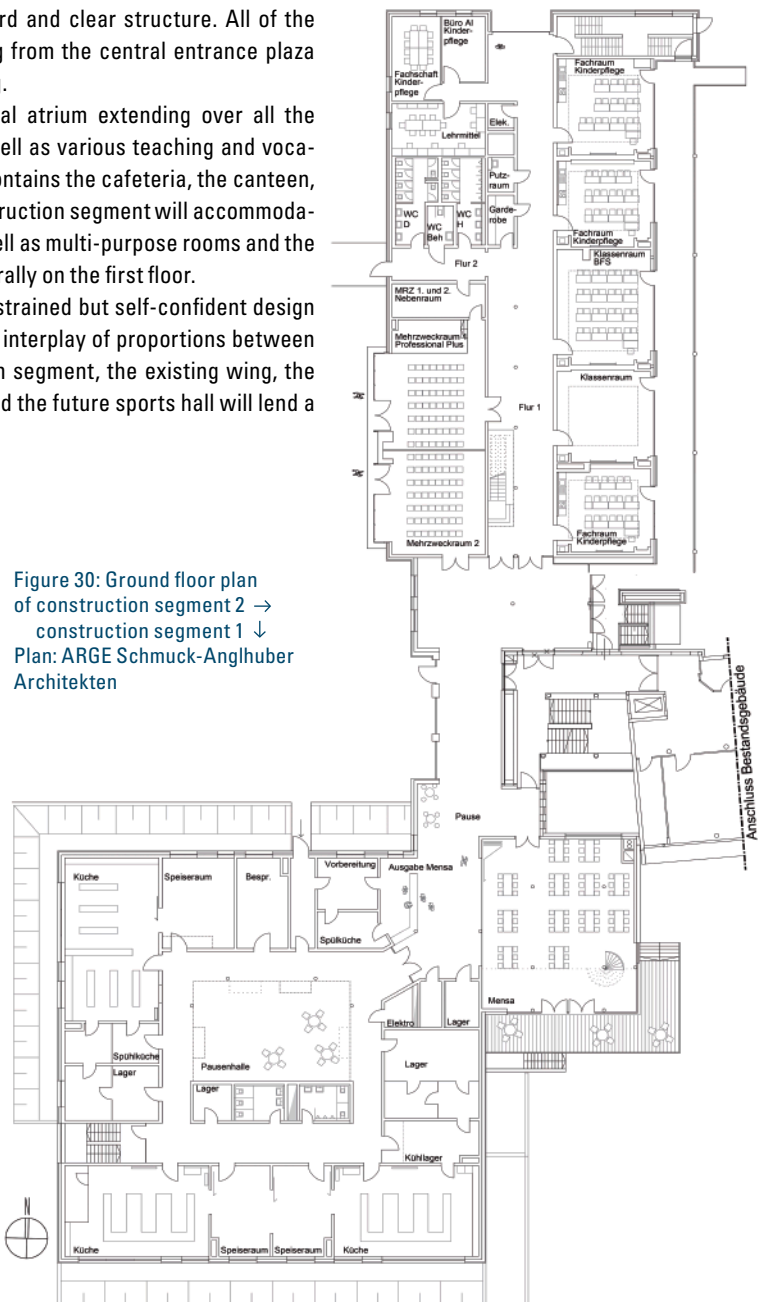

Figure 30: Ground floor plan of construction segment 2 → construction segment 1 ↓  
 Plan: ARGE Schmuck-Anglhuber Architekten

### Components

The solid external walls feature a 24-cm layer of thermal insulation covered with a rear-ventilated façade. The windows were designed as wood/aluminium windows with triple thermal insulation glazing. Some of the windows are fitted with auto-controlled solar protection.

The solid reinforced concrete roof has a 35-cm layer of thermal insulation. The 15-cm fibre-reinforced concrete floor slab rests on top of pressure-resistant perimeter insulation with a thickness of 12 cm. The floor covering is installed on a floating screed with an insulating layer measuring 11 cm in thickness.

Table 17: List of U-values for the building envelope components

Component	U-value [WW per m <sup>2</sup> per Kelvin]
External wall	0.14
Windows	0.82
Roof	0.11
Floor slab	0.14

Systems engineering

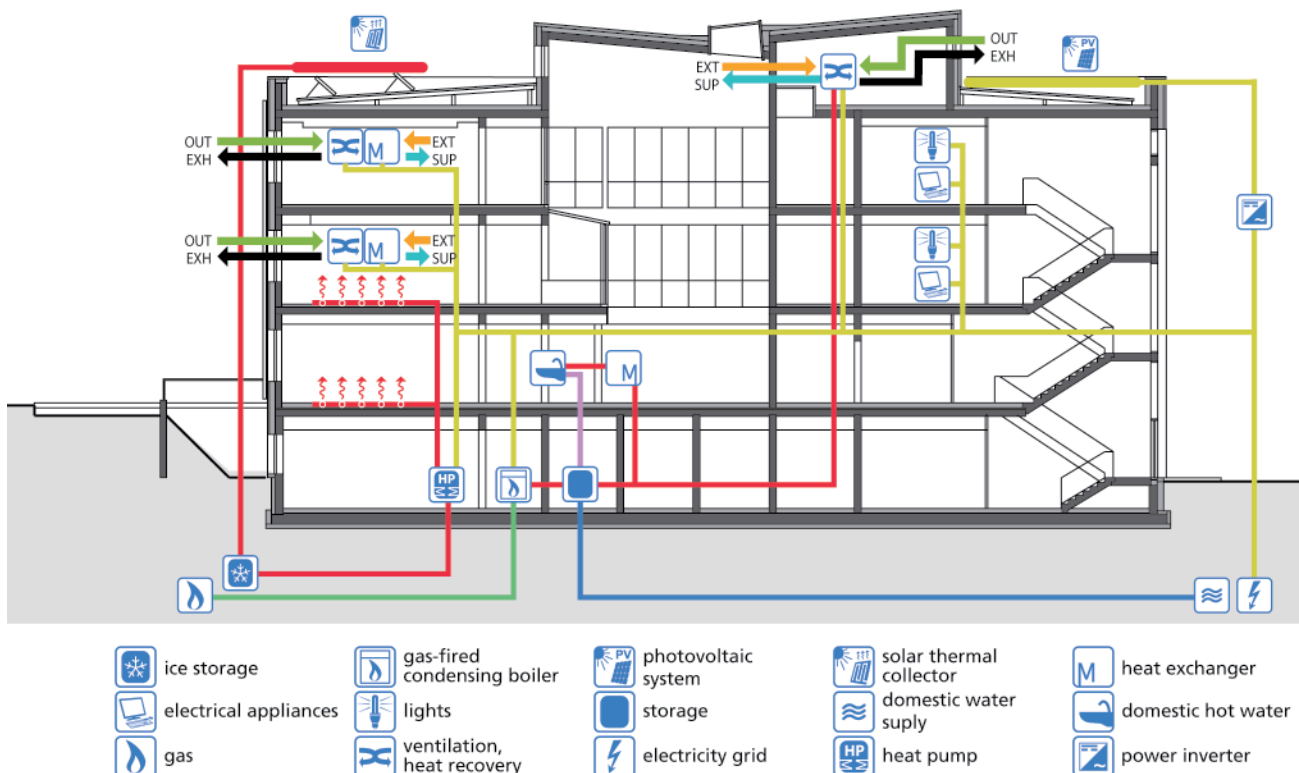

Figure 33: Longitudinal cross-section through the building and design of the building services  
Diagram: Fraunhofer IBP



Figure 34: The central ventilation system  
Photograph: COPLAN AG



Figure 35: The heat pump in the plant room  
Photograph: COPLAN AG



Figure 36: The solar absorber system on the roof  
Photograph: COPLAN AG

The building complex will be supplied with heat by a 150-kW brine-water heat pump in combination with an ice storage unit (380 m<sup>3</sup>) and solar absorbers (217 m<sup>2</sup>) to cover the base load. A gas condensing peak load boiler will also be installed as a supplementary source of heat. The heat will be distributed via a four-pipe system. The low-temperature distribution system (45/35°C) will be fed by the heat pump and supply the panel heater systems in the new-build structures. The high-temperature distribution system (70/40°C) will be fed by the condensing boiler and supply the central domestic hot water system (domestic water tanks) for the cafeteria and the student bakery, the central ventilation system and the heating system in the existing building. The waste heat from the cold storage cells of the student bakery and the cafeteria are routed back to the low-temperature network. The panel heater systems are used as cooling surfaces during the summer months.

Central mechanical ventilation systems with a heat recovery rate of 90% ensure a high level of indoor air comfort in the cafeteria, the canteen, the break room and the washrooms. The air is thermally treated in a preheater before it is delivered to the rooms. Decentralised ventilation units with electric post-heating coils are installed in the classrooms, special subject rooms and administration rooms. It is planned that new modules with monocrystalline solar cells will be fitted on the roofs of the school complex alongside the existing PV modules with a view to covering the building's final energy demand. The system as a whole is designed to cover an area of 2,563 m<sup>2</sup>, with an output of around 410 kW<sub>p</sub>.

## Energy

According to the calculations, the new build requires 367,023 kWh of final energy per year (38.2 kWh per m<sup>2</sup><sub>heatedNFA</sub> per year) in the form of electricity and natural gas. Of this figure, around half (47 %) is used to operate building services systems; electrical equipment (37 %) and lighting (16 %) play a secondary role in this respect. Under average climatic conditions, the PV system on the roof of the school complex generates 376,960 kWh of renewable energy per

year; the resulting annual surplus in the final energy balance is anticipated to be 9,937 kWh per year. It is expected that 51 % of the electricity generated locally by the PV system will be used in the building itself, and that 49 % will be fed into the grid or used in the other buildings in the complex. In terms of primary energy calculations, the balance surplus is forecast to be 263,360 kWh per year.

## Final energy

Table 18: Final energy demand

Component	Energy demand	
	[kWh per year]	[kWh per square metre per year] <sup>1)</sup>
Heating/domestic hot water (natural gas)	77,165	8.0
Heating (electricity)	54,036	5.6
Auxiliary energy for heating, domestic hot water, ventilation (electricity)	41,322	4.3
Lighting (electricity)	57,764	6.0
Electrical equipment	136,736	14.2 <sup>2)</sup>
<sup>1)</sup> related to heated net floor area of 9,596 m <sup>2</sup>		
<sup>2)</sup> higher demand determined during planning		
<b>Total</b>	<b>367,023 kWh per year</b>	

Table 19: Final energy coverage

Component	Energy yield	
	[kWh per year]	[kWh per square metre per year] <sup>3)</sup>
PV system on roof	376,960 <sup>4)</sup> (290,663) <sup>5)</sup>	147.1 (113.4)
<sup>3)</sup> related to PV module area on roof of 2,563 m <sup>2</sup>		
<sup>4)</sup> according to DIN V 18599 (2011) with nominal module power		
<sup>5)</sup> according to DIN V 18599 (2011) with standard values and reference climate Potsdam		
<b>Total</b>	<b>376,960 kWh per year</b>	

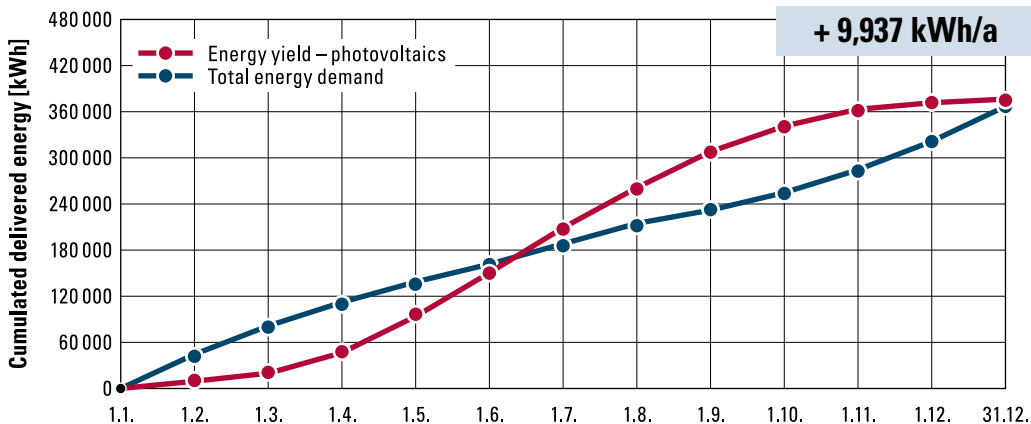

Figure 37: Predicted final energy surplus; Chart: Fraunhofer IBP

## Primary energy

Table 20: Primary energy supply from external sources

Component	Primary energy demand for each needed energy source	
	[kWh per year] <sup>6)</sup>	[kWh per square metre per year] <sup>1)</sup>
Natural gas	76,470	8.0
Electricity demand (HVAC + lighting)	82,266	8.6
Demand for electrical equipment according to the Efficiency House Plus standard	90,440	9.4
<sup>1)</sup> related to heated net floor area of 9,596 m <sup>2</sup>		
<sup>6)</sup> 51 % of the PV energy yield is used by the building itself and thus reduces the energy needed from the grid		
<b>Total</b>	<b>249,175 kWh per year</b>	

Table 21: Primary energy credit due to grid feed-in

Component	Electricity surplus	
	[kWh per year] <sup>7)</sup>	[kWh per square metre per year] <sup>3)</sup>
PV-Dach	512,535	200.0
<sup>3)</sup> related to PV module area on roof of 2,563 m <sup>2</sup>		
<sup>7)</sup> 49 % of the PV energy yield is fed into the grid		
<b>Total</b>	<b>512,535 kWh per year</b>	

[status of energy parameters: September 2017]

# Jakob Brucker Upper Secondary School in Kaufbeuren

The energy surplus calculated for the new build and renovated structure covers the annual electricity consumption of 12 average four-person households in Germany.\*

\*) corresponds to 27 t CO<sub>2</sub> per year



Figure 38: Top floor of the central atrium in the new build (Building B)  
Photograph: mse architekten



## Model project

### Jakob Brucker Upper Secondary School in Kaufbeuren



Figure 39: Visualisation of the south side of the new build  
Visualisation: köhler architekten

#### General data

Table 22: Selection of general information on the building and the project participants

Location	Neugablonzer Straße 38, 87600 Kaufbeuren
Year of construction	2017–2020
Building owner	Town of Kaufbeuren
Architect	köhler architekten + beratende ingenieure, Gauting in cooperation with mse architekten gmbh, Kaufbeuren
Monitoring	EA Systems Dresden GmbH; Dresden University of Technology, Institute of Power Engineering (IET)
Technical building equipment	Güttinger Engineers, Kempten

Table 23: Selection of building parameters

Gross floor area	8,996 m <sup>2</sup>
Heated net floor area	8,521 m <sup>2</sup>
Heated building volume	33,349 m <sup>3</sup>
Building envelope factor A/V	0.41 m <sup>-1</sup>
Number of classrooms/ special subject rooms/ common rooms	48
Total area of teaching rooms	3,469 m <sup>2</sup>

#### Project description

A large-scale renovation and extension project, divided into three construction segments, is planned for the Jakob Brucker Upper Secondary School in Kaufbeuren. Construction segment 1 of this larger project was completed in March 2019, when the new build was occupied for the first time. The new Technical Centre (*Technikum*) (Building B), which was built to the Efficiency House Plus standard, accommodates the natural science classrooms. Construction of the new build has been completed, and the next stage involves renovation of the existing Building A. In the interests of bringing the building back up to modern-day teaching requirements, the renovation plans reflect the state of the art in terms of energy use, functionality, fire protection and noise insulation.



Figure 40: Site plan of the entire complex  
Plan: köhler architekten

### Architecture

The new wing accommodating the special subject classrooms (Building B) was constructed between two existing structures (Buildings A and D). It can be accessed from two footbridges on the first floor that are also easily accessible for persons with disabilities. The footbridges also provide protection against the elements for people moving between the buildings using the outdoor routes. The special subject classrooms are arranged around the central atrium over both floors. The physics department and the nature and

technology department are combined in a single zone on the ground floor, while the same is true for the chemistry department and the biology department on the top floor.

Open recreational and learning areas are located in front of the special subject classrooms on the ground and top floor; these areas are not merely circulation zones, but can be used for a wide variety of purposes. Multiple skylights in the central atrium provide adequate lighting.

The large-scale renovation of Building A will involve not only eliminating structural deficits, but also making significant improvements to spatial relationships. Rooms will be regrouped, certain areas will be repurposed and wasted space will be utilised in order to compensate for the spatial deficits that have been identified within the existing building envelope. A revised fire protection concept will allow the school to use the open learning areas in the building's interior without restrictions; these areas are interconnected through shared open spaces that extend across multiple floors.

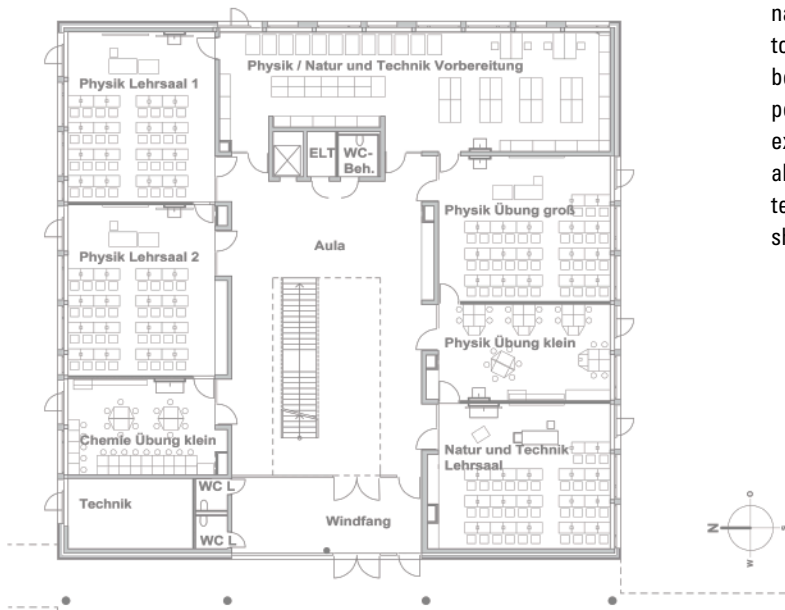

Figure 41: Ground floor plan of the new build, Building B  
Plan: köhler architekten



Figure 42: North side of the new build and outdoor area  
Photograph: Town of Kaufbeuren



Figure 43: One of the specialist practice rooms  
Photograph: Town of Kaufbeuren



Figure 44: The assembly hall in the atrium of the new build  
Photograph: mse architekten

### Components

The solid external walls in the new build feature a back-ventilated metal façade and a 24-cm layer of thermal insulation. The windows were designed as aluminium windows with triple thermal insulation glazing. The flat roof is made from reinforced concrete and features a layer of tapered insulation measuring on average 40 cm in thickness. The 30-cm floor slab was laid directly on the subsurface. Its upper side features a 9-cm layer of insulation that was covered with a floating screed. A 22-cm layer of insulation was applied to the external side of the strip footings in the base area down to a depth of 1.20 m below ground.

During the ground-up renovation of Building A (an existing structure), the windows will be replaced and the exterior components will be thermally optimised.

Table 24: List of U-values for the building envelope components

Component	U-value [W per m <sup>2</sup> per Kelvin]	
	New build, Building B	Renovation, Building A
External wall	0.16	0.16
Windows	0.80	0.80
Skylights	1.00	1.50
Roof	0.10	0.10
Floor slab	0.38 0.14*	1.70

\*) including correction factor pursuant to DIN EN ISO 13370

## Systems engineering

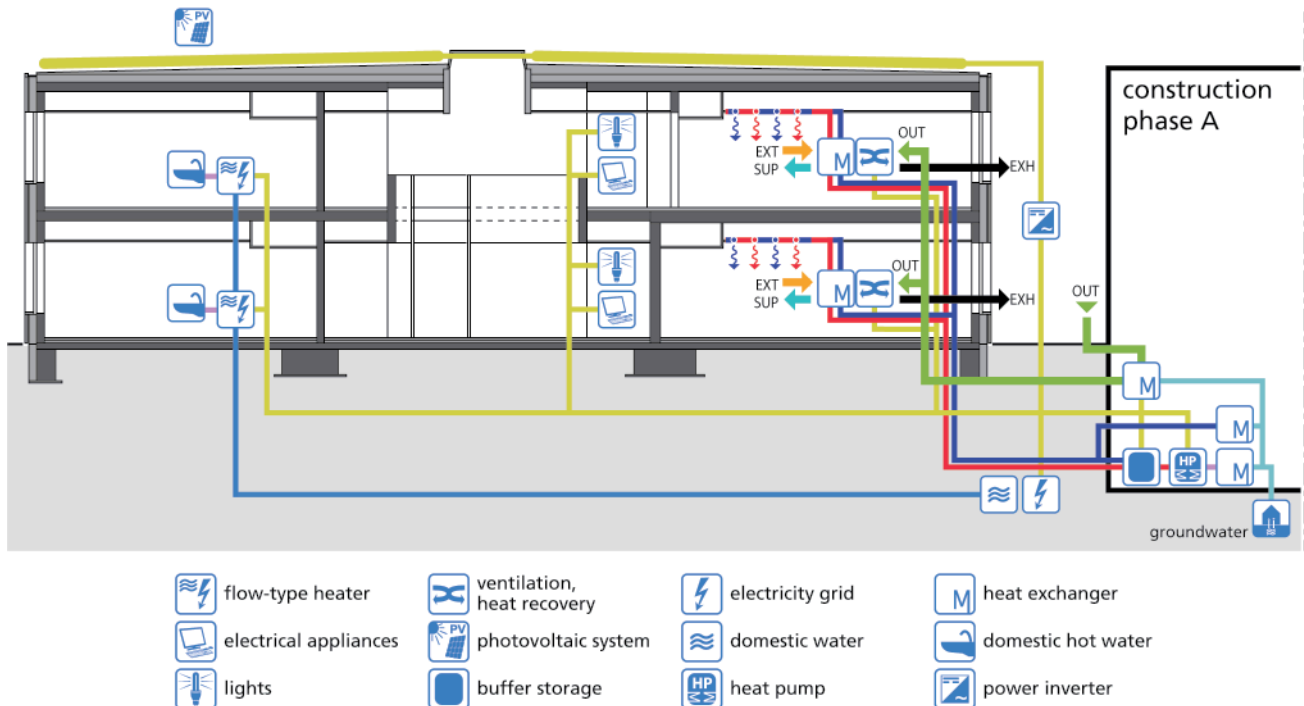

Figure 45: Longitudinal section through the new build (Building B) and design of building services  
Diagram: Fraunhofer IBP



Figure 46: PV system on the roof of the new build  
Photograph: Town of Kaufbeuren



Figure 47: Detailed view of the façade showing the air inlets/outlets  
Photograph: Town of Kaufbeuren



Figure 48: Supply air slot diffusers in the ceilings  
Photograph: Güttinger Ingenieure

Water-water heat pumps with a planned total output of 172.2 kW will be installed in the main building (Building A). Groundwater from Kaufbeuren's Old Town (located around 500 m away) will be used as a source of heat. Two existing buffer storage tanks with a volume of 1,500 litres each and two new storage tanks with a total volume of around 10,000 litres will be used as heat reservoirs. The heat from Building A will be transported to the new-build structure (Building B) via a local heating pipe.

Ceiling panel heaters or decentralised ventilation units will be used to distribute heating or cooling to the rooms. The supply air is preheated centrally by the available groundwater (anti-freeze protection) or pre-cooled and then distributed to the decentralised ventilation units through embedded pipes in the ground. The ventilation units are fitted with a hydraulic post-heating coil with heating and cooling functions, and boast a heat recovery rate of 90%. Downstream of the ventilation unit, the heated and chilled ceilings are supplied through a two-pipe system (low-tech hydraulics). The

control panel for the ventilation units regulates the air conditioning of the room as a whole (volume of air, actuation of heated/chilled ceilings or heating coil, ventilation). The decentralised ventilation concept also allows for the windows to be opened at any time for ventilation purposes.

Electric flow-type heaters are used to heat domestic hot water on a distributed basis in selected rooms.

Monocrystalline PV systems covering an area of around 1,787 m<sup>2</sup> will be installed on the roofs of the buildings. The total output of the systems is around 334 kW<sub>p</sub>. Surplus electricity will be transformed into heat using a heating element in the buffer storage tank, or fed into the public grid.



## Energy

According to the calculations, the buildings require 276,574 kWh of electricity per year (32.5 kWh per m<sup>2</sup><sub>heated NFA</sub> per year). Of this figure, more than half (61 %) is used to operate building services systems; electrical equipment (31 %) and lighting (8 %) play a secondary role in this respect. According to a PV simulation at the location of Kaufbeuren, the PV systems on the roofs of the school complex generate 326,508 kWh of renewable energy per year, resulting in an anticipated annual surplus of 49,934 kWh per year in the final energy balance. It is expected that 57 % of the electricity generated locally by the PV systems will be used in the building itself, and that 43 % will be fed into the grid or used in the other buildings in the complex. In terms of primary energy calculations, the balance surplus is forecast to be 229,203 kWh per year.

anticipated annual surplus of 49,934 kWh per year in the final energy balance. It is expected that 57 % of the electricity generated locally by the PV systems will be used in the building itself, and that 43 % will be fed into the grid or used in the other buildings in the complex. In terms of primary energy calculations, the balance surplus is forecast to be 229,203 kWh per year.

## Final energy

Table 25: Final energy demand

Component	Energy demand	
	[kWh per year]	[kWh per square metre per year] <sup>1)</sup>
Heating/domestic hot water (electricity)	97,843	11.5
Cooling (electricity)	6,427	0.8
Auxiliary energy for heating, cooling, domestic hot water, ventilation (electricity)	65,712	7.7
Lighting (electricity)	21,385	2.5
Electrical equipment	85,207	10.0
<sup>1)</sup> related to heated net floor area of 8,521 m <sup>2</sup>		
<b>Total</b>	<b>276,574 kWh per year</b>	

Table 26: Final energy coverage

Component	Energy yield	
	[kWh per year]	[kWh per square metre per year] <sup>2)</sup>
PV system on roof	326,508 <sup>3)</sup> (202,623) <sup>4)</sup>	182.8 (113.4)
<sup>2)</sup> related to PV module area on roof of 1,787 m <sup>2</sup> <sup>3)</sup> according to PV simulation with the location Kaufbeuren <sup>4)</sup> according to DIN V 18599 (2011) with standard values and reference climate Potsdam		
<b>Total</b>	<b>326,508 kWh per year</b>	

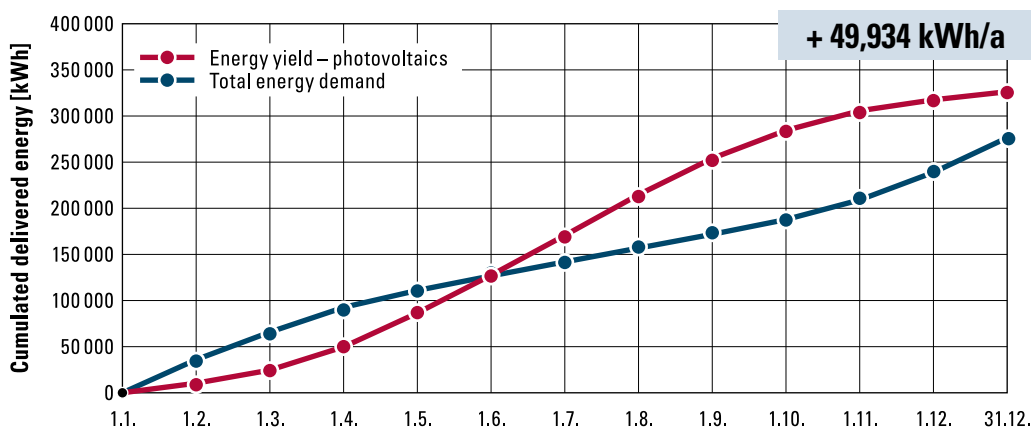

Figure 49: Predicted final energy surplus, Chart: Fraunhofer IBP

## Primary energy

Table 27: Primary energy supply from external sources

Component	Primary energy demand for each needed energy source	
	[kWh per year] <sup>5)</sup>	[kWh per square metre per year] <sup>1)</sup>
Electricity demand (HVAC + lighting)	106,590	12.5
Demand for electrical equipment according to the Efficiency House Plus standard	54,312	6.4
<sup>1)</sup> related to heated net floor area of 8,521 m <sup>2</sup> <sup>5)</sup> 57 % of the PV energy yield is used by the building itself and thus reduces the energy needed from the grid		
<b>Total</b>	<b>160,902 kWh per year</b>	

Table 28: Primary energy credit due to grid feed-in

Component	Electricity surplus	
	[kWh per year] <sup>6)</sup>	[kWh per square metre per year] <sup>2)</sup>
PV system on roof	390,105	218.4
<sup>2)</sup> related to PV module area on roof of 1,787 m <sup>2</sup> <sup>6)</sup> 43 % of the PV energy yield is fed into the grid		
<b>Total</b>	<b>390,105 kWh per year</b>	

[status of energy parameters: May 2020]

# Research hall at Ansbach University of Applied Sciences in Feuchtwangen

The predicted annual energy surplus of the research hall is roughly enough to power an electric car from Berlin to Lisbon and back – seven times.\*

\*) corresponds to 4 t CO<sub>2</sub> per year



Figure 50: Bird's-eye view from the south-east onto the research hall  
Photograph: City of Feuchtwangen



## Model project

### Research hall at Ansbach University of Applied Sciences in Feuchtwangen



Figure 51: View from the south-west towards the research hall and the adjacent solar air absorber block  
Photograph: Dr Reinhardt Reck

#### General data

Table 29: Selection of general information on the building and the project participants

Location	An der Hochschule 1, 91555 Feuchtwangen
Year of construction	2017–2018
Building owner	City of Feuchtwangen
Architect	HEF – Holzinger Eberl Fürhäufer Architekten Ansbach, in cooperation with the Feuchtwan- gen Municipal Planning and Building Control Office ( <i>Stadtbauamt</i> )
Monitoring	ina Planungsgesellschaft mbH, Darmstadt
Technical building equipment	Bautz Ingenieurbüro, Ansbach

Table 30: Selection of building parameters

Gross floor area	608 m <sup>2</sup>
Heated net floor area	531 m <sup>2</sup>
Heated building volume	3,119 m <sup>3</sup>
Building envelope factor A/V	0.47 m <sup>-1</sup>
Number of seminar rooms	1
Total area of seminar room	54 m <sup>2</sup>

#### Project description

The City of Feuchtwangen is planning to construct a teaching and research unit for energy-related courses of study within the Faculty of Applied Engineering Sciences at the Ansbach University of Applied Sciences. The complex of buildings will accommodate seminar rooms, offices and laboratory areas, and will be built in two construction segments. It is envisaged that infrastructures and building services will be shared between the two buildings, allowing synergies to be leveraged and investment costs to be cut. Building 102 – the “research hall”, located to the east – was built to the Efficiency House Plus standard in an initial stage, and research and teaching commenced in February 2018. According to the plans, the next stage will involve the construction of Building 101 (“Lecture Room Building”).



Figure 52: Site plan of the entire complex  
Plan: HEF Architekten

### Architecture

Building 102 is a two-storey building oriented in a north/south direction, which has a flat roof and no basement. It is accessed from the west, and was the first building to be erected on Campus Feuchtwangen. This simple “wooden box” accommodates a two-storey research hall that can be used to set up test benches. An

office for evaluating test outcomes and a kitchenette, store room, WCs and a plant room for the building are located on the ground floor, next to the hall. Additional offices and a seminar room are situated on the top floor and can be accessed via a gallery area within the hall itself.

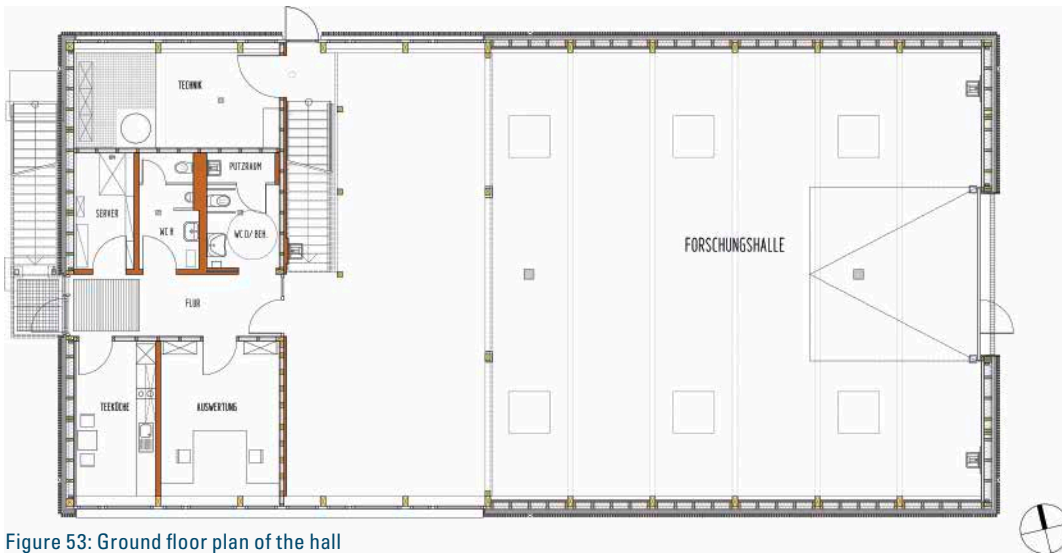

Figure 53: Ground floor plan of the hall  
 Plan: HEF Architekten



Figure 54: View into the seminar room  
 Photograph: ZEBAU



Figure 55: In the hall – offices viewed from the front  
 Photograph: City of Feuchtwangen



Figure 56: Below the office gallery – view into the hall  
 Photograph: City of Feuchtwangen

### Components

The building was designed as a wooden structure on a solid floor slab with a solid base area. The external walls were designed as wooden stud walls with back-ventilated Douglas fir cladding in the form of vertical slats, insulated with wood fibre insulation.

The windows were designed as wood/aluminium windows with triple glazing. Permanent solar protection with rigid hollow slats was added on the south side. The windows on the west side were fitted with solar control glazing and no further external solar protection. Rooflight domes were installed in the roof area.

The roof was designed as a flat roof. A veneer plywood panel was installed on the roof trusses; the thermal insulation, roof waterproofing and green roof are arranged on top of this panel. The 35-cm floor slab rests on top of pressure-resistant foam glass insulation with a thickness of 16 cm. The floor slab was rotary trowel finished in the hall area, and finished with a floating screed and floor covering in the other areas.

Table 31: List of U-values for the building envelope components

Component	U-value [W per m <sup>2</sup> per Kelvin]
External wall	0.17
Windows	0.95
Rooflight dome	1.70
Roof	0.13
Floor slab	0.26

## Systems engineering

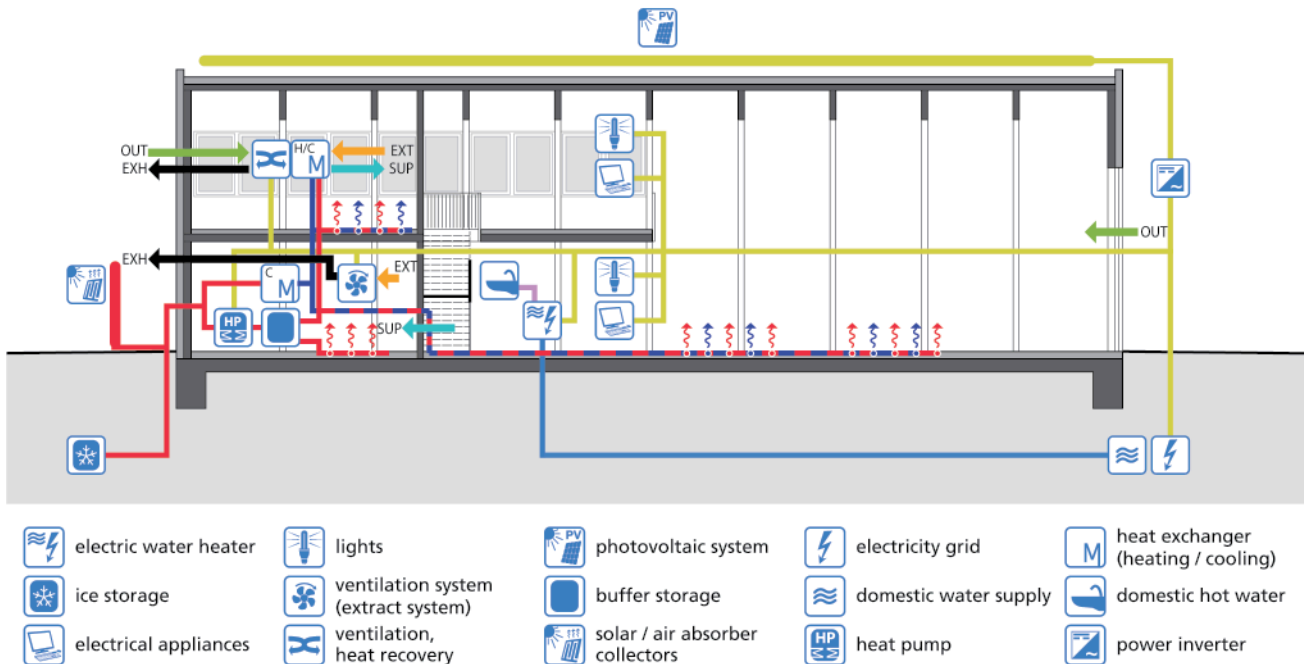

Figure 57: Longitudinal cross-section through the research hall and design of the building services  
Diagram: Fraunhofer IBP



Figure 58: PV system on the roof of the hall  
Photograph: City of Feuchtwangen



Figure 59: The building services control room  
Photograph: City of Feuchtwangen



Figure 60: The solar air absorber block  
Photograph: City of Feuchtwangen

The energy supply concept is based on the use of electricity. Heat is generated using a brine-water heat pump (B0/W35) with a heat output of 28.8 kW. The source of heat for the heat pump is an ice storage unit with a volume of 273 m<sup>3</sup>, in combination with a block of 20 solar air absorbers with an absorption area of 46.8 m<sup>2</sup>, which are installed on the exterior, on the west side of the building. A buffer storage tank with a volume of 1,500 litres is connected to the heat pump.

Different toggle modes for the systems technologies allow the building to be heated or cooled either by operating the collectors alone or by loading and unloading the ice storage unit.

The rooms are heated and cooled using panel systems. Underfloor heating has been installed in the offices, while the research hall is heated to a lower thermal level through thermal activation of the floor slab. The target room temperatures are 17°C for the hall and 21°C for all other rooms, and the temperature is controlled on a room-by-room basis.

Additional air conditioning for the seminar room is provided by means of a controlled supply and exhaust air system with heat recovery. An exhaust air system is installed in the WCs. The domestic

hot water for the kitchenette is heated instantaneously using an electric boiler.

With a view to covering the building's final energy demand, 150 PV modules with monocrystalline solar cells have been installed on the roof, with an incline of 15 degrees towards the east, west and south. The system as a whole covers an area of 246 m<sup>2</sup> and has a standard output of 33.2 kW<sub>p</sub>.

### Energy

According to the calculations, the building requires 18,709 kWh of electricity per year (35.2 kWh per m<sup>2</sup><sub>heatedNFA</sub> per year). Of this figure, around half (54 %) is used to operate building services systems; electrical equipment (28 %) and lighting (18 %) play a secondary role in this respect. Under average climatic conditions, the PV system on the roof of the research hall generates 26,681 kWh of renewable energy per year; the resulting annual surplus in the final energy

balance is anticipated to be 7,972 kWh per year. It is expected that 47 % of the electricity generated locally by the PV system will be used in the building itself, and that 53 % will be fed into the grid. In terms of primary energy calculations, the balance surplus is forecast to be 28,559 kWh per year.

### Final energy

Table 32: Final energy demand

Component	Energy demand	
	[kWh per year]	[kWh per square metre per year] <sup>*)</sup>
Heating/domestic hot water (electricity)	5,714	10.8
Cooling (electricity)	1,688	3.2
Auxiliary energy for heating, cooling, domestic hot water, ventilation (electricity)	2,656	5.0
Lighting (electricity)	3,341	6.3
Electrical equipment	5,310	10.0
*) related to heated net floor area of 531 m <sup>2</sup>		
<b>Total</b>	<b>18,709 kWh per year</b>	

Table 33: Final energy coverage

Component	Energy yield	
	[kWh per year] <sup>*)</sup>	[kWh per square metre per year] <sup>*)</sup>
PV system on roof	26,681	108.5
*) related to PV module area on roof of 246 m <sup>2</sup> *) according to DIN V 18599 (2011) with standard values and reference climate Potsdam		
<b>Total</b>	<b>26,681 kWh per year</b>	

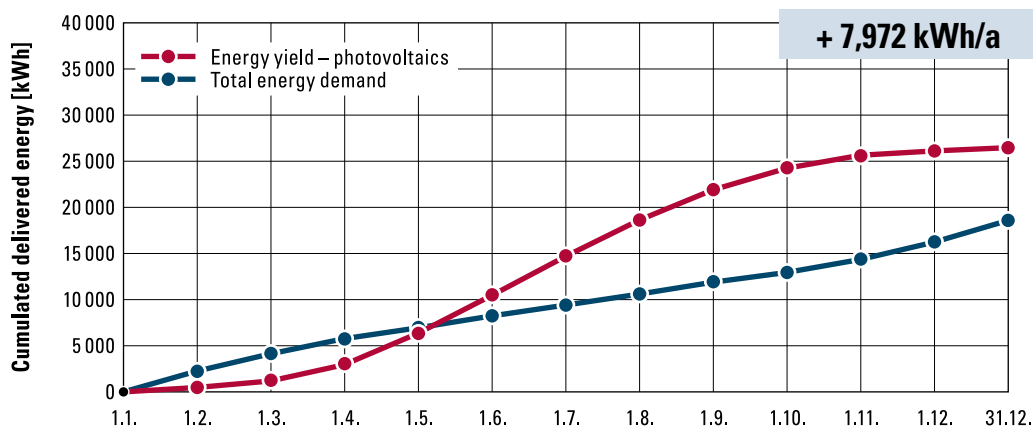

Figure 61: Predicted final energy surplus, Chart: Fraunhofer IBP

### Primary energy

Table 34: Primary energy supply from external sources

Component	Primary energy demand for each needed energy source	
	[kWh per year] <sup>*)</sup>	[kWh per square metre per year] <sup>*)</sup>
Electricity demand (HVAC + lighting)	8,088	15.2
Demand for electrical equipment according to the Efficiency House Plus standard	3,142	5.9
*) related to heated net floor area of 531 m <sup>2</sup> *) 47 % of the PV energy yield is used by the building itself and thus reduces the energy needed from the grid		
<b>Total</b>	<b>11,230 kWh per year</b>	

Table 35: Primary energy credit due to grid feed-in

Component	Electricity surplus	
	[kWh per year] <sup>*)</sup>	[kWh per square metre per year] <sup>*)</sup>
PV system	39,789	161.7
*) related to PV module area of 246 m <sup>2</sup> *) 53 % of the PV energy yield is fed into the grid		
<b>Total</b>	<b>39,789 kWh per year</b>	

[status of energy parameters: July 2018]

# Extension at Giebelstadt Primary School

The energy surplus calculated for the new extension saves 10 tonnes of CO<sub>2</sub> each year.



Figure 62: View from the south-east onto the new extension built at Giebelstadt Primary School  
Photograph: Haase & Bey Architekten





## Model project

### Extension at Giebelstadt Primary School



Figure 63: View of the extension's south side  
Photograph: Haase & Bey Architekten

#### General data

Table 36: Selection of general information on the building and the project participants

Location	Grundschule Giebelstadt, Schulstraße 1, 97232 Giebelstadt
Year of construction	2017–2018
Building owner	Municipality of Giebelstadt
Architect	Haase & Bey Architekten PartG mbB, Karlstadt
Monitoring	Dresden University of Technology, Institute of Power Engineering; EA Systems Dresden GmbH
Technical building equipment	HGT Ingenieure GmbH, Eibelstadt

Table 37: Selection of building parameters

Gross floor area	730 m <sup>2</sup>
Heated net floor area	624 m <sup>2</sup>
Heated building volume	3,058 m <sup>3</sup>
Building envelope factor A/V	0.63 m <sup>-1</sup>
Number of classrooms/ special subject rooms/ common rooms	7
Total area of teaching rooms	256 m <sup>2</sup>

#### Project description

The existing building that accommodates Giebelstadt Primary School has undergone a previous energy renovation. As a result of rising pupil numbers, it now needs to be extended to include a structure providing space for the lunchtime and afternoon supervision of pupils, and this extension has been designed in accordance with the Efficiency House Plus standard. The one-storey new build has no basement, and is a compact structure with roofs at different angles (one at an angle of 15 degrees and one flat) in order to achieve the ideal conditions for a PV system at the same time as providing natural lighting for the corridors.

The school grounds also house a single-court sports hall built in the 1970s, which is to be replaced by a triple-court gymnasium as part of the next construction segment (not covered by the scope of this programme).

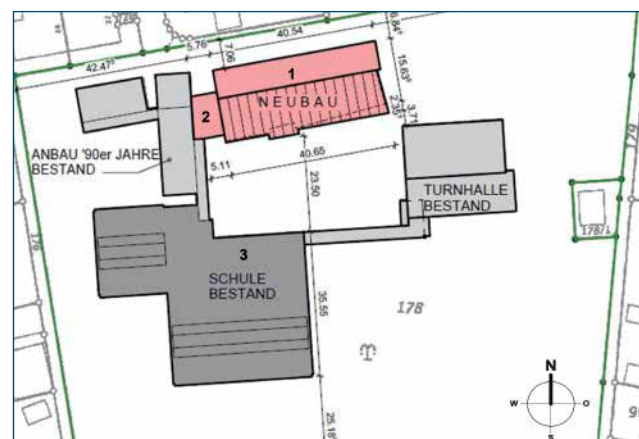

Figure 64: Site plan of the entire complex  
Plan: Haase & Bey Architekten

### Architecture

The new extension at Giebelstadt Primary School contains rooms designed to be used when supervising pupils at lunchtime, and is connected to the existing annex (built in the 1990s) via a connecting structure. Most of the space on the north side of the extension is taken up by common rooms used for various purposes, WCs and the kitchen serving hatch. The dining room, pupil library, lunchtime supervision rooms and an office are located to the south of the corridor. The low-lying connecting structure accommodates an addi-

tional office and a foyer.

The extension has a timber-frame design. In the interests of fire protection, the external walls of the connecting structure are solid masonry. The saw-tooth roof of the extension features a continuous strip of windows on the north side, providing natural lighting and ventilation for the corridor. The partition walls in the pupil library feature generously sized skylights to increase illumination.



Figure 65: Ground floor plan of the extension  
Plan: Haase & Bey Architekten



Figure 66: Corridor area leading to the common rooms  
Photograph: Haase & Bey Architekten



Figure 67: View into the dining room  
Photograph: Haase & Bey Architekten



Figure 68: Reading room for pupils  
Photograph: Haase & Bey Architekten

### Components

The foyer's solid external walls feature a 20-cm layer of mineral wool thermal insulation on the exterior and are plastered on both sides. The 34-cm external walls of the main extension have a wooden structure with 1.5-cm OSB panels for bracing purposes on the interior and 6-cm wood-fibre insulation panels with external mineral render on the exterior. Cellulose thermal insulation was blown into the 20-cm interstice. On the room side, the walls are panelled with gypsum plasterboard.

The wood/aluminium windows feature triple thermal insulation glazing. Motorised external blinds offer protection against solar radiation.

The 22-cm suspended wooden plank ceiling covered with gypsum plasterboard has a 16-cm layer of thermal insulation on the upper side and a roller-seam-welded sheet of stainless steel across the entire roof. The 18-cm floor slab rests on top of a 16-cm layer of

Table 38: List of U-values for the building envelope components

Component	U-value [W per m <sup>2</sup> per Kelvin]
External wall	0.16
Windows	0.85
Roof	0.13
Floor slab	0.17

pressure-resistant insulation. The floor covering is applied to a floating poured asphalt screed.

## Systems engineering

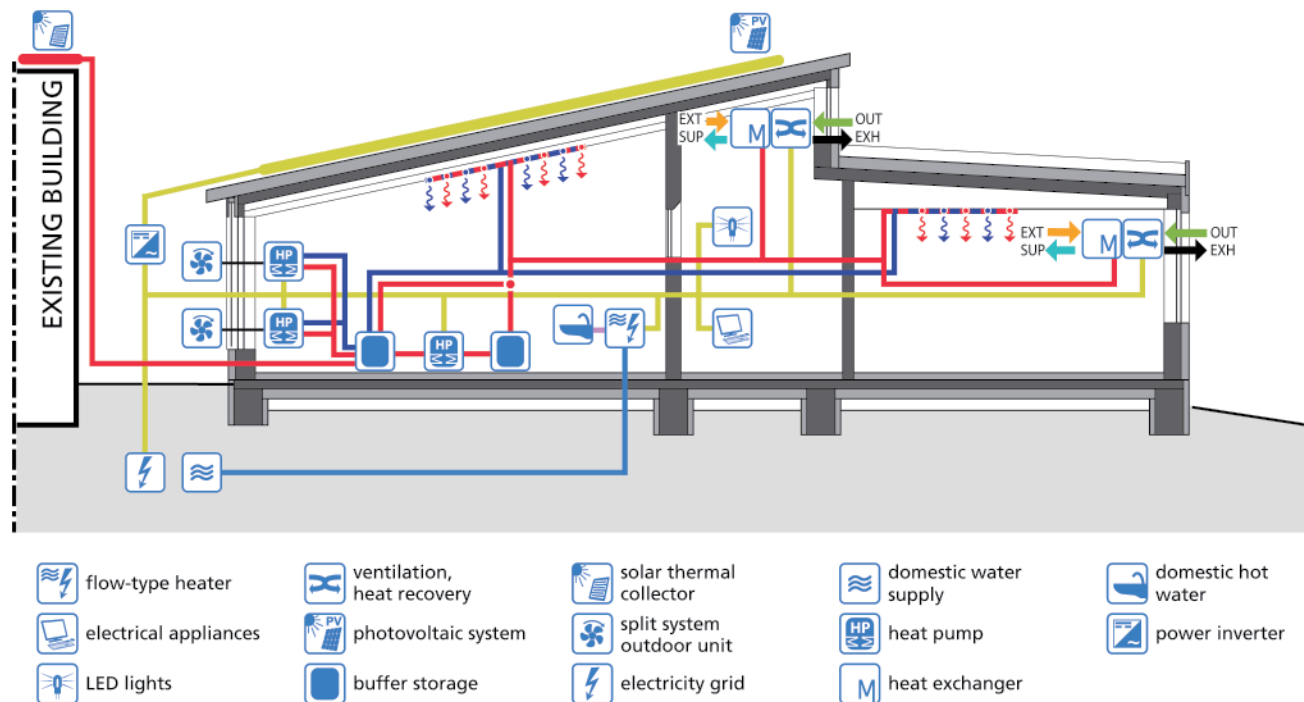

Figure 69: Longitudinal cross-section through the building and design of the building services  
Diagram: Fraunhofer IBP

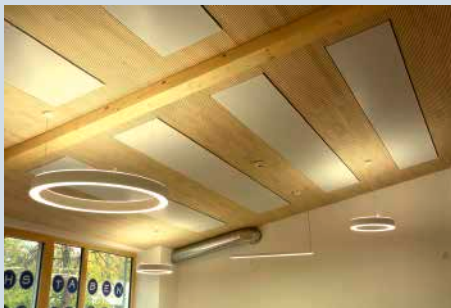

Figure 70: Ceiling heating panels, LED luminaires  
Photograph: Haase & Bey Architekten



Figure 71: The plant room  
Photograph: Haase & Bey Architekten



Figure 72: Heat pump and stratified storage tank  
Photograph: Haase & Bey Architekten

The new building operates independently of the existing building in that it is supplied with heat from a system of several sequential (cascading) heat pumps. Two air-water heat pumps, each with a rated output of 11.2 kW, heat a cold storage tank (with a volume of 1,000 litres) to a low temperature (around 15°C). A downstream water-water heat pump with an output of 17 kW uses the cold storage tank as a source of heat and generates heat for the purpose of heating water; the domestic hot water is stored in an additional stratified storage tank, which also has a nominal volume of 1,000 litres. Excess solar thermal energy from the existing building can also be fed into the cold storage tank. Heat is distributed from the heat reservoir through two heating circuits: one for the ceiling heating panels and one for the ventilation systems. Downstream air heaters ensure that the supply air can be heated to a minimum base temperature. The system can be used for active cooling during the summer months.

The decentralised ventilation systems, which boast a heat recovery rate of around 80%, typically supply several rooms and are regula-

ted according to humidity and CO<sub>2</sub> levels. The demand for domestic hot water is low, and so it is heated directly using an electric boiler. The heat pumps are supplied mainly with electricity generated in-house by the PV system, which covers an area of 323 m<sup>2</sup> and has a rated output of 55.4 kW<sub>p</sub>.

LED technology is used to illuminate the entire building, with manual controls. The only areas where the lighting is switched on and off automatically are the corridors and the WCs.

## Energy

According to the calculations, the building requires 26,310 kWh of electricity per year (42.2 kWh per m<sup>2</sup><sub>heatedNFA</sub> per year). Of this figure, the majority (65 %) is used to operate building services systems; electrical equipment (24 %) and lighting (12 %) play a secondary role in this respect. Under average climatic conditions, the PV system on the roof of the primary school generates 45,375 kWh of renewable energy per year; the resulting annual surplus in the final energy

balance is anticipated to be 19,065 kWh per year. It is expected that 40 % of the electricity generated locally by the PV system will be used in the building itself, and that 60 % will be fed into the grid or used in the existing buildings within the complex. In terms of primary energy calculations, the balance surplus is forecast to be 61,690 kWh per year.

## Final energy

Table 39: Final energy demand

Component	Energy demand	
	[kWh per year]	[kWh per square metre per year] <sup>1)</sup>
Heating/domestic hot water (electricity)	12,300	19.7
Cooling (electricity)	1,813	2.9
Auxiliary energy for heating, cooling, domestic hot water, ventilation (electricity)	2,925	4.7
Lighting (electricity)	3,032	4.9
Electrical equipment	6,240	10.0
*) related to heated net floor area of 624 m <sup>2</sup>		
<b>Total</b>	<b>26,310 kWh per year</b>	

Table 40: Final energy coverage

Component	Energy yield	
	[kWh per year]	[kWh per square metre per year] <sup>2)</sup>
PV system on roof	45,375 <sup>3)</sup> (32,411) <sup>4)</sup>	140.5 (100.3)
*) related to PV module area on roof of 323 m <sup>2</sup> ) according to DIN V 18599 (2011) with nominal module power ) according to DIN V 18599 (2011) with standard values and reference climate Potsdam		
<b>Total</b>	<b>45,375 kWh per year</b>	

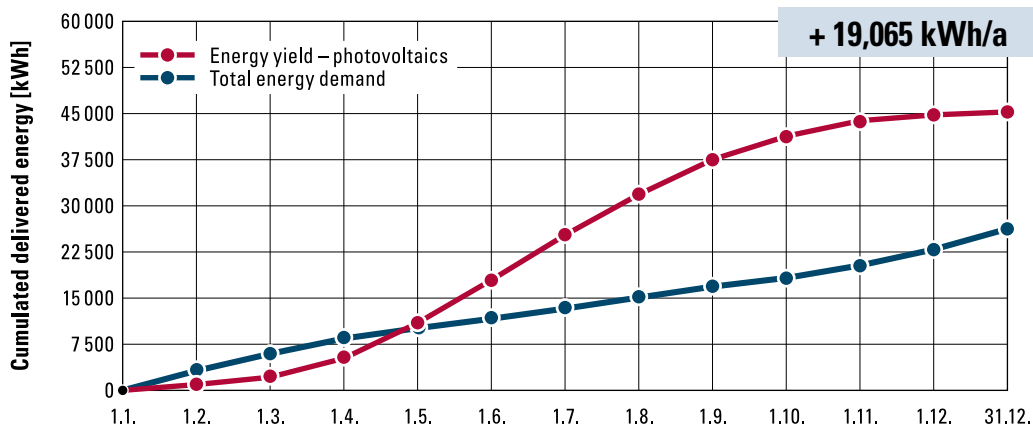

Figure 73: Predicted final energy surplus, Chart: Fraunhofer IBP

## Primary energy

Table 41: Primary energy supply from external sources

Component	Primary energy demand for each needed energy source	
	[kWh per year] <sup>5)</sup>	[kWh per square metre per year] <sup>1)</sup>
Electricity demand (HVAC + lighting)	11,267	18.1
Demand for electrical equipment according to the Efficiency House Plus standard	3,639	5.9
*) related to heated net floor area of 624 m <sup>2</sup> ) 40 % of the PV energy yield is used by the building itself and thus reduces the energy needed from the grid		
<b>Total</b>	<b>14,960 kWh per year</b>	

Table 42: Primary energy credit due to grid feed-in

Component	Electricity surplus	
	[kWh per year] <sup>6)</sup>	[kWh per square metre per year] <sup>2)</sup>
PV system	76,650	237.3
*) related to PV module area on roof of 323 m <sup>2</sup> ) 60 % of the PV energy yield is fed into the grid		
<b>Total</b>	<b>76,650 kWh per year</b>	

[status of energy parameters: September 2018]

# Replacement building at Ulm University

The planned electricity feed-in from the PV system will create an annual carbon sink equivalent to 48 hectares of forest.



Figure 74: During the construction phase – view of the construction project from the south  
Photograph: SPREEN ARCHITEKTEN



## Model project

### Replacement building at Ulm University



Figure 75: Visualisation of the building from the north-west  
Visualisation: SPREEN ARCHITEKTEN

#### General data

Table 43: Selection of general information on the building and the project participants

Location	Albert-Einstein-Allee 53, 89081 Ulm
Year of construction	2018–2020
Building owner	Land of Baden-Württemberg, represented by Assets and Construction Baden-Württemberg, Ulm Office
Architect	Concept planning (work phases 1–4): Assets and Construction Baden-Württemberg, Ulm Office; Project scheduling (work phases 5–8): SPREEN ARCHITEKTEN Partnerschaft mbB, Munich; Construction phase (work phases 6–8): planer gmbh sterr-ludwig, Blaustein
Monitoring	Fraunhofer Institute for Building Physics (IBP), Department of Energy Efficiency and Indoor Climate, Holzkirchen
Technical building equipment	ee concept, Darmstadt; Planungsgruppe M+M AG, Böblingen, with technical support from Assets and Construction Baden-Württemberg, Ulm Office and Ulm University

Table 44: Selection of building parameters

Gross floor area	11,291 m <sup>2</sup>
Heated net floor area	10,003 m <sup>2</sup>
Heated building volume	47,949 m <sup>3</sup>
Building envelope factor A/V	0.25 m <sup>-1</sup>
Number of rooms for research and teaching	38
Total floor area of rooms for research and teaching	4,144 m <sup>2</sup>

#### Project description

The replacement building has been designed to the Efficiency House Plus standard and will be located on Albert-Einstein-Allee, to the east of the existing university building; together with these buildings, it will form the new Oberer Eselsberg university campus in Ulm. The new structure replaces the property on Eberhardt-Finck-Straße in Ulm-Böfingen, the renovation of which was long overdue, and will accommodate the institutes that make up the Faculty of Electrical Engineering and the Faculty of Information Technology. The building will be used for teaching and research purposes, and contains highly specialised laboratory areas, offices, meeting rooms and seminar rooms as well as a library.

Compliance with the Efficiency House Plus standard means that the building meets the requirements imposed by the Land of Baden-Württemberg, which aims to achieve a largely climate-neutral building stock by 2050.



Figure 76: Site plan of the entire complex  
Plan: Koeber Landschaftsarchitektur



### Architecture

The new build is designed as a compact, square-shaped, four-storey building, and will be constructed adjacent to the existing university building. The shared open space between the two buildings will ensure that they function as a single complex. The clear structure of the building heightens its impact. Although the inner courtyards have different designs, they both provide transparency, lighting and

ventilation inside the building, and link the floors together visually. The laboratory areas are grouped around these two inner courtyards.

Offices and seminar rooms are also arranged around this central structure, looking onto Albert-Einstein-Allee and the adjacent green space. Specialised laboratories and workshops are located in the basement, on the east of the building.

It is anticipated that the main entrance foyer will be used for a variety of purposes. When it is being used for events, it can be expanded to include the outdoor space in the adjacent west-facing inner courtyard. On a day-to-day basis, the foyer area can be used as a central meeting point and an area where students can work.

Part of the flat roof above the laboratory areas is designed to be used as an experimental site by the university. The rest of the roof is covered entirely by PV systems for purpose of generating energy.



Figure 77: Ground floor plan  
Plan: Assets and Construction Baden-Württemberg



Figure 78: East side of the building  
Photograph: SPREEN ARCHITEKTEN



Figure 79: View into the narrow inner courtyard  
Photograph: SPREEN ARCHITEKTEN



Figure 80: View out of the stairwell  
Photograph: SPREEN ARCHITEKTEN

### Components

The compact building is designed as a solid structure with concrete ceilings and reinforced concrete wall slabs in the form of semi-finished elements. The building envelope has been designed to be airtight, and the structural details have been designed to avoid thermal bridging. The exterior walls comprise semi-finished reinforced concrete elements that serve a load-bearing purpose, covered with a facing panel that incorporates a 19-cm layer of thermal insulation.

The windows are designed as wooden windows with triple solar control glazing. Exterior solar protection has been installed on all windows.

The roof has a flat design and accommodates the tilt-mounted PV system. A vapour barrier and a 28-cm layer of thermal insulation are installed on the uppermost solid ceiling slab, and serve as a basis for the roof waterproofing.

Table 45: List of U-values for the building envelope components

Component	U-value [WW per m <sup>2</sup> per Kelvin]
External wall	0.18
Windows	0.80
Roof	0.14
Floor slab	0.27

The 60-cm floor slab will be placed on a 40-cm layer of foam glass gravel and sealed; it will then be used to support a floating screed with a 6-cm layer of thermal insulation and a 2-cm layer of footfall noise insulation. A surface coating will be applied to the screed in the seminar rooms and offices.

## Systems engineering

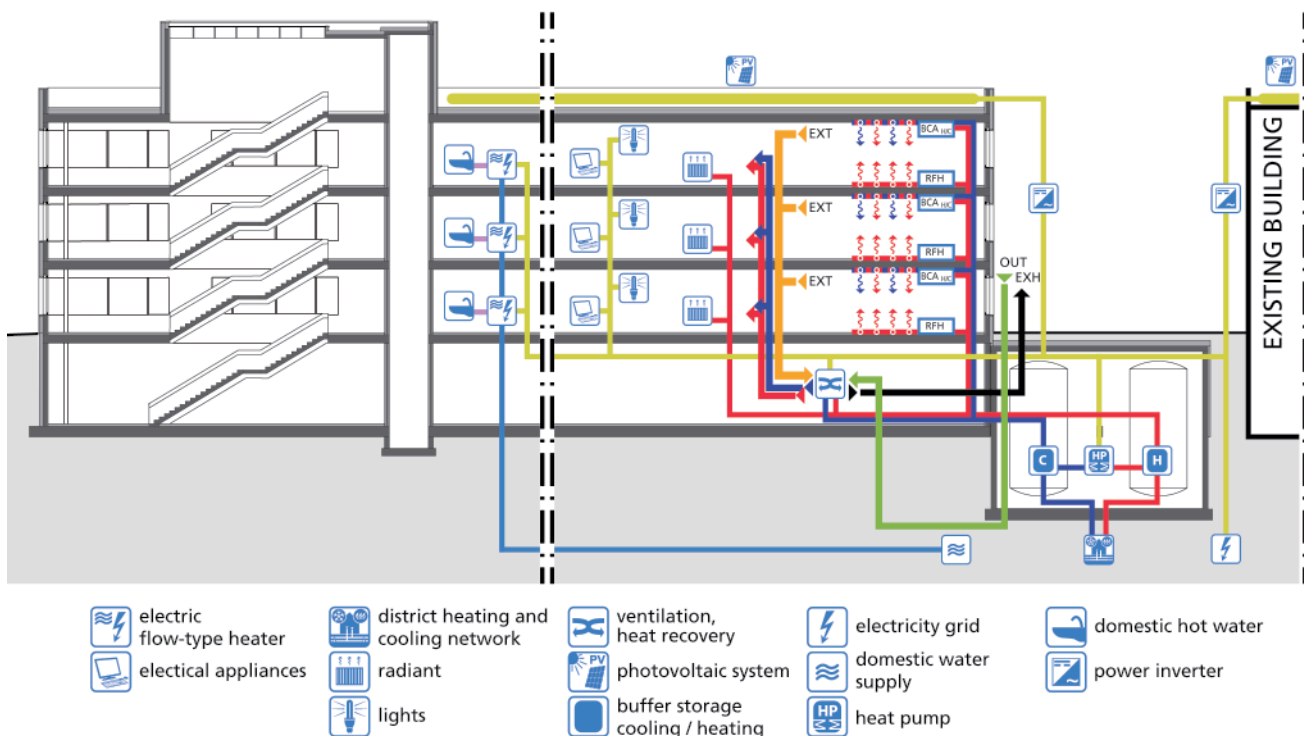

Figure 81: Longitudinal cross-section through the building and design of the building services  
Diagram: Fraunhofer IBP

A reversible water-water heat pump will be used to heat or cool the building. The system has a maximum heating output of 145 kW and a maximum cooling output of 85 kW. Use of the extensive district cooling network already present on the campus grounds as a source of heat means that the building's final energy demand can be reduced to a minimum. The cooling energy generated during heat production is fed back into the district cooling network as useful energy. This decreases the energy demand of the district cooling network. The amount of cooling energy decreased is credited to the building and regarded as an energy feed-in in the energy balance of the Efficiency House Plus standard.

One buffer storage tank with a volume of 50 m<sup>3</sup> is installed on both the heating side and the cooling side for the purpose of optimising system operation. The district heating connection covers peak loads. Heat is transferred through building component activation, underfloor heating, radiators and (in the seminar rooms and laboratory areas) the ventilation system which is required there. Domestic

hot water for the WCs and kitchenettes is provided on a decentralised basis using electric flow-type heaters.

The seminar/training rooms and plant/ancillary rooms are each supplied with fresh air by a single ventilation system. Outdoor air is taken in through a walkable floor duct; as it passes through this channel, the outdoor air is also pre-conditioned. Both systems are fitted with a highly efficient circuit-connected system for heat recovery purposes. The air is preheated to a constant value when the building is being heated. The system used in the seminar/training rooms has an additional adiabatic exhaust air cooling feature for the purpose of cooling the outdoor air during the summer months, which covers the basic cooling load of the rooms. The quantity of supply air is regulated according to need, depending on the CO<sub>2</sub> content of the air. The remaining rooms are ventilated naturally. Just under 1,900 m<sup>2</sup> of high-performance PV modules will be installed on the new build and the existing building to cover the building's final energy demand. The total system output is around 370 kW<sub>p</sub>.

## Energy

According to calculations, the building requires 677,603 kWh of final energy per year (67.7 kWh per m<sup>2</sup><sub>heatedNFA</sub> per year) in the form of electricity, district heating and district cooling. Of this figure, the majority (69%) is used to operate building services systems; electrical equipment (24%) and lighting (7%) play a secondary role in this respect. According to a simulation at the location of Ulm, the PV system on the university's roof generates 373,231 kWh of renewable electricity per year. Use of the district cooling network as a source of energy by the heat pump means that the network's central cooling unit needs to supply less cooling energy (to the tune of 321,156 kWh) each year. The electricity generated by the PV system

and the cooling energy fed into the public grid result in an anticipated annual surplus of 16,784 kWh per year in the final energy balance. It is expected that 75% of the electricity generated locally by the PV system will be used in the building itself, and that 25% will be fed into the grid. In terms of primary energy calculations, the balance surplus is forecast to be 51,530 kWh per year.

### Final energy

Table 46: Final energy demand

Component	Energy demand	
	[kWh per year]	[kWh per square metre per year] <sup>1)</sup>
Heating (district heating)	126,585	12.7
Heating/domestic hot water (electricity)	92,836	9.3
Cooling (district cooling)	123,723	12.4
Cooling (electricity)	51,509	5.1
Auxiliary energy for heating, cooling, domestic hot water, ventilation (electricity)	74,318	7.4
Lighting (electricity)	48,580	4.9
Electrical equipment	160,052	16.0
<sup>1)</sup> related to heated net floor area of 10,003 m <sup>2</sup>		
<b>Total</b>	<b>677,603 kWh per year</b>	

Table 47: Final energy coverage

Component	Energy yield	
	[kWh per year]	[kWh per square metre per year]
PV system on roof	373,231 <sup>3)</sup> (203,934) <sup>4)</sup>	198.5 <sup>2)</sup> (108.5) <sup>2)</sup>
Kälteeinspeisung	321,156	32.1 <sup>1)</sup>
<sup>1)</sup> related to heated net floor area of 10,003m <sup>2</sup>		
<sup>2)</sup> related to PV module area of 1,880 m <sup>2</sup>		
<sup>3)</sup> according to PV simulation with the location Ulm		
<sup>4)</sup> according to DIN V 18599 with standard values and reference climate Potsdam		
<b>Total</b>	<b>694,387 kWh per year</b>	

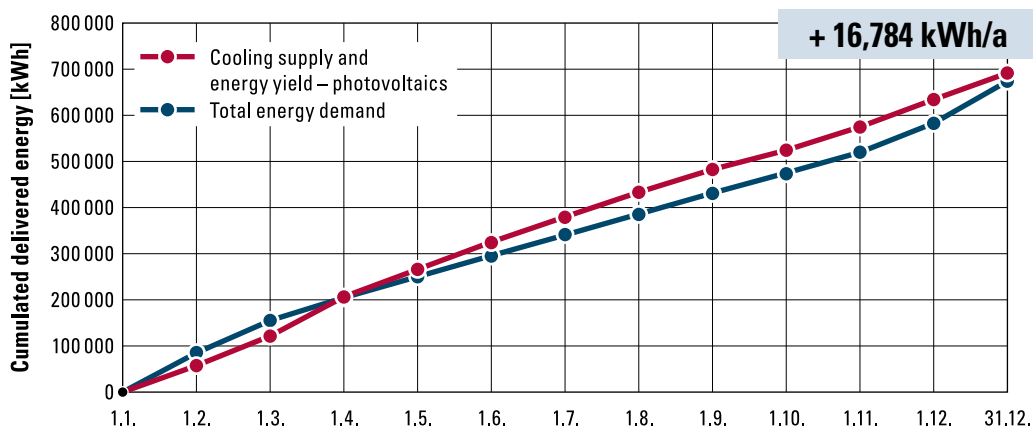

Figure 82: Predicted final energy surplus, Chart: Fraunhofer IBP

### Primary energy

Table 48: Primary energy supply from external sources

Component	Primary energy demand for each needed energy source	
	[kWh per year] <sup>5)</sup>	[kWh per square metre per year] <sup>1)</sup>
Local district heating	25,317	2.5
District cooling	50,726	5.1
Electricity demand (HVAC + lighting)	129,311	12.9
Demand for electrical equipment according to the Efficiency House Plus standard	135,787	13.6
<sup>1)</sup> related to heated net floor area of 10,003 m <sup>2</sup>		
<sup>5)</sup> 75 % of the PV energy yield is used by the building itself and thus reduces the energy needed from the grid		
<b>Total</b>	<b>341,141 kWh per year</b>	

Table 49: Primary energy credit due to grid feed-in

Component	Electricity surplus	
	[kWh per year] <sup>6)</sup>	[kWh per square metre per year]
PV system	260,997	138.8 <sup>2)</sup>
Feed into district cooling	131,674	13.2 <sup>1)</sup>
<sup>1)</sup> related to heated net floor area of 10,003 m <sup>2</sup>		
<sup>2)</sup> related to PV module area of 1,880 m <sup>2</sup>		
<sup>6)</sup> 25 % of the PV energy yield is fed into the grid		
<b>Total</b>	<b>392,671 kWh per year</b>	

## Cross-evaluation of Planning data

The goal pursued when constructing an educational building to the Efficiency House Plus standard is to ensure that the renewable energy generated locally over the course of a year exceeds the energy required for the building's operation and use. The Efficiency House Plus standard is technology-neutral and characterised by a smart combination of energy-efficient construction technologies, building services and renewable energy generation systems.

The seven educational buildings to be evaluated under the "Efficiency House Plus – Educational Buildings" funding programme are all very different. This section contains a systematic comparison of the planning data for these buildings. The key parameters for the educational buildings involved in the initiative were calculated on a building-specific basis by specialist planners. The comparative analysis of these key parameters was carried out by the Fraunhofer Institute for Building Physics (IBP) within the framework of an accompanying research project.

### Heated net floor area as reference area

The seven pilot projects involve a range of different educational institutions with very different purposes and uses of space. The model projects range from a single-storey extension at Giebelstadt Primary School to accommodate the provision of all-day care through to a three-storey replacement building at Ulm University containing specialist laboratories and workshops. Most of the construction projects involve new builds; in the case of Neutraubling Upper Secondary School and Jakob Brucker Upper Secondary School, however, large-scale renovations will also be carried out

in accordance with the Efficiency House Plus standard. Since the model projects involve buildings of very different sizes, the building parameters (key parameters) that have been calculated are placed in relation to the heated net floor area of each building to facilitate comparisons. Figure 83 illustrates the reference areas for the relevant projects, listed here according to the nature of the educational institution (primary school, upper secondary schools, vocational school centres and, finally, universities).







	Heated net floor area $A_{\text{hea, NFA}}$						
	Extension at Giebelstadt Primary School	Neutraubling Upper Secondary School	Jakob Brucker Upper Secondary School in Kaufbeuren	Vocational school centre Louise Otto-Peters School in Hockenheim	Vocational school centre in Mühldorf am Inn	Research hall at Ansbach University of Applied Sciences in Feuchtswangen	Replacement building at Ulm University of Applied Sciences
New building	531 m <sup>2</sup>	3,545 m <sup>2</sup>	1,956 m <sup>2</sup>	3,766 m <sup>2</sup>	9,596 m <sup>2</sup>	624 m <sup>2</sup>	10,003 m <sup>2</sup>
Refurbishment		6,843 m <sup>2</sup>	6,565 m <sup>2</sup>				
Total	531 m <sup>2</sup>	10,388 m <sup>2</sup>	8,521 m <sup>2</sup>	3,766 m <sup>2</sup>	9,596 m <sup>2</sup>	624 m <sup>2</sup>	10,003 m <sup>2</sup>
Visualisation of the areas							

Figure 83: Reference areas for the seven pilot projects with the respective proportions for new-build structures and renovated structures  
Chart: Fraunhofer IBP

### Framework conditions for the energy concept

The energy concept for an Efficiency House Plus building is determined in large part by the renewable energy potentials that are accessible locally. In the case of the educational buildings that participated in the initiative, the figures involved ranged between 30 and 73 kWh per m<sup>2</sup><sub>heated NFA</sub> per year. The buildings require between 13 and 21 kWh per m<sup>2</sup><sub>heated NFA</sub> per year for lighting and electrical equipment. This alone corresponds to a range between 20% and 51% of the renewable energy potentials that are accessible locally, meaning that a maximum final energy demand for building services systems (heating, domestic hot water, ventilation) between

16 and 58 kWh per m<sup>2</sup><sub>heated NFA</sub> per year would result in a positive annual energy balance.

### Ventilation concepts

Ventilation is a particularly important consideration in educational buildings. To comply with hygiene requirements, air must be renewed at a rate appropriate for rooms that are used by large numbers of people. Optimum cognitive performance – which is a vital prerequisite for pupils' learning success – depends to a very large extent on high-quality indoor air conditions. The ventilation concepts for the individual buildings are very different in their design, and are influenced heavily by the way in which these buildings are used. All of the buildings feature mechanical systems; some are decentralised (i.e. they operate on a room-by-room basis) and some

are centralised (i.e. they operate on the basis of building segments). These two concepts are combined in the Jakob Brucker Upper Secondary School in Kaufbeuren and in the vocational school centre in Mühldorf am Inn; in both instances, the classrooms are ventilated using decentralised ventilation systems. All of the systems feature heat recovery systems with high heat recovery rates (70% to 90%). Almost all of the ventilation systems are regulated on the basis of indoor air quality and allow natural ventilation during the summer months.

	Ventilation concept						
	Louise Otto-Peters School in Hockenheim	Neutraubling Upper Secondary School	Vocational school centre in Mühldorf am Inn	Jakob Brucker Upper Secondary School in Kaufbeuren	Research hall at Ansbach University in Feuchtwangen	Extension at Giebelstadt Primary School	Replacement building at Ulm University
Decentralised							
Centralised							
Heat recovery	84 %	83 %	90 %	87 %	81 %	80 %	71 %

Figure 84: Ventilation concepts in the model projects, with details of heat recovery efficiency  
Chart: Fraunhofer IBP

### Thermal protection of the building envelope

In addition to heat losses through ventilation, the thermal insulation of the building envelope has a significant impact on a building's heating energy demand. The thermal protection required to minimise the maximum heating energy demand is high-quality but not exceptional.

The heat transmission coefficients (U-values) of the buildings constructed within the framework of the model projects are 39% to 68% lower than the U-values used for the notional building according to the Buildings Energy Act. Based on this assessment, the parameters for the heat-exchanging building envelope components of Efficiency House Plus buildings are 50% better than the corresponding U-values for the notional building.

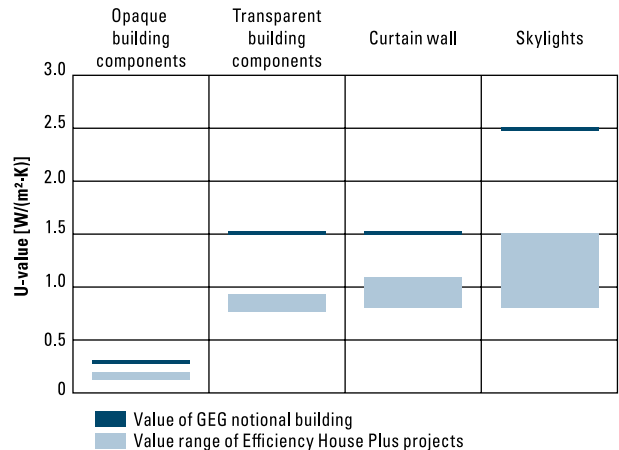

Figure 85: Heat transmission coefficients (U-values) of the heat-exchanging components of the building envelope  
Chart: Fraunhofer IBP

### Heat supply

As far as the supply of heat is concerned, all of the pilot projects use heat pumps that operate on the basis of local renewable heat sources. Three of the seven model projects use a combination of thermal solar systems and ice storage units as a source of heat for heat pumps. Neutraubling Upper Secondary School and Jakob Brucker Upper Secondary School in Kaufbeuren use groundwater as a source of heat, and Giebelstadt Primary School uses outdoor air for this purpose. The source of energy for the reversible heat pump in the replacement building at Ulm University is the university's cooling network; the return flow temperature of this network is lowered as a result. The energy withdrawn in the process no longer needs to be generated in the network's central cooling unit and thus represents a saving. Some of the heat pumps are supplied with

heat by additional heat generators, e.g. a gas condensing boiler or district heating. At Jakob Brucker Upper Secondary School in Kaufbeuren, groundwater is used on a supplementary basis for direct pre-heating of the outdoor air. In addition, any surplus electricity from the PV system is transformed into heat by means of a heat element in the buffer storage tank. Since the individual projects implement a wide range of different concepts, the thermal rated outputs of the heat pumps cover an extremely large spectrum. The buildings with monovalent heating systems based on heat pumps have thermal nominal outputs of between 22 and 63 W per m<sup>2</sup><sub>heatedNFA</sub>. The figure for Neutraubling Upper Secondary School is significantly lower, which can be attributed to the use of large heat reservoirs. Furthermore, the heat pump output to be installed as part of this

project was calculated by means of a simulation study diverging from the planning standards in agreement with the building owner. This reduced the design output further. The heat pump systems in

the buildings where heat pumps cover only the basic load have thermal rated outputs between 8 and 20 W per m<sup>2</sup><sub>heatedNFA</sub>.

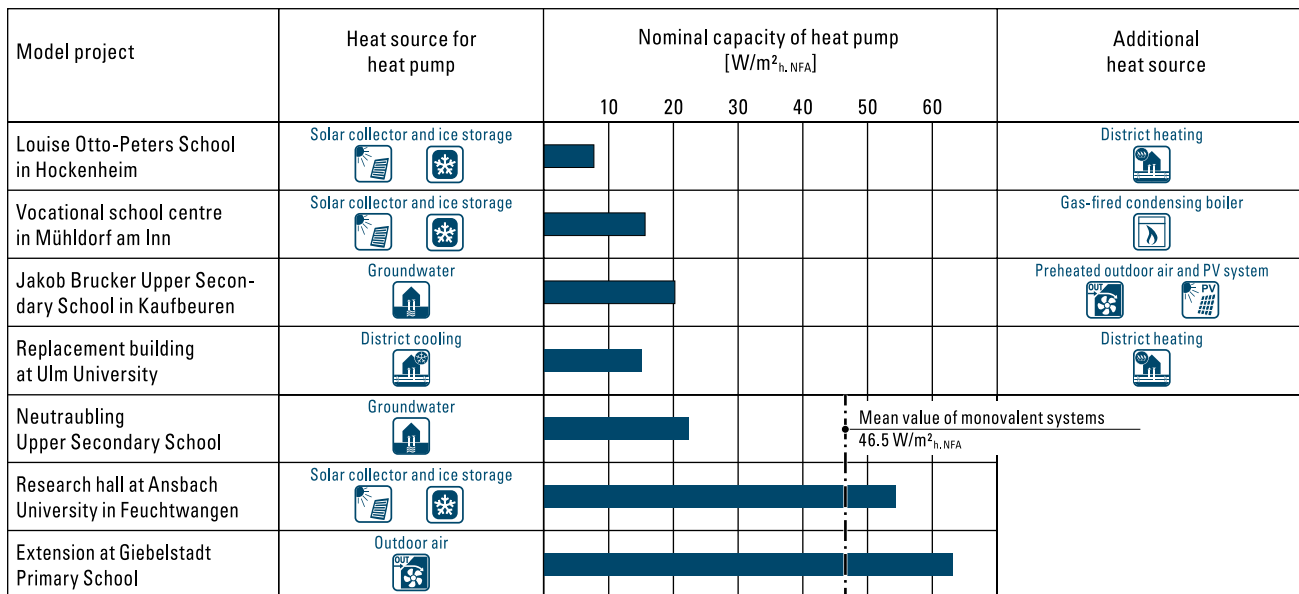

Figure 86: Installed thermal rated output of heat pump systems  
Chart: Fraunhofer IBP

**Electrical equipment**

When assessing buildings built to the Efficiency House Plus standard, the scope of energy balances under the Buildings Energy Act is expanded to include energy demand for appliances (under the heading of “electrical equipment”). In the event that consumers have not been identified in detail at the planning stage, it can be assumed that a flat-rate value for electrical equipment of 10 or 15 kWh per m<sup>2</sup><sub>heatedNFA</sub> per year will apply (the former figure if the use of particularly energy-efficient appliances is guaranteed, and the latter figure otherwise). It is nevertheless preferable for the anticipated demand to be identified in detail at the planning stage. For example, detailed calculations carried out by planning teams result-

ed in a figure of 14 kWh per m<sup>2</sup><sub>heatedNFA</sub> per year for electrical equipment in the Vocational School Centre in Mühl Dorf, and a figure of 16 kWh per m<sup>2</sup><sub>heatedNFA</sub> per year for the replacement building at Ulm University, in both cases as a result of special-purpose uses (e.g. in special subject classrooms or laboratories). The electricity demand for appliances is significantly higher than the electricity demand for lighting in all of the educational buildings under investigation. The total energy demand for appliances and lighting in the model projects varies between 13 and 21 kWh per m<sup>2</sup><sub>heatedNFA</sub> per year, with an average figure of around 16 kWh per m<sup>2</sup><sub>heatedNFA</sub> per year.

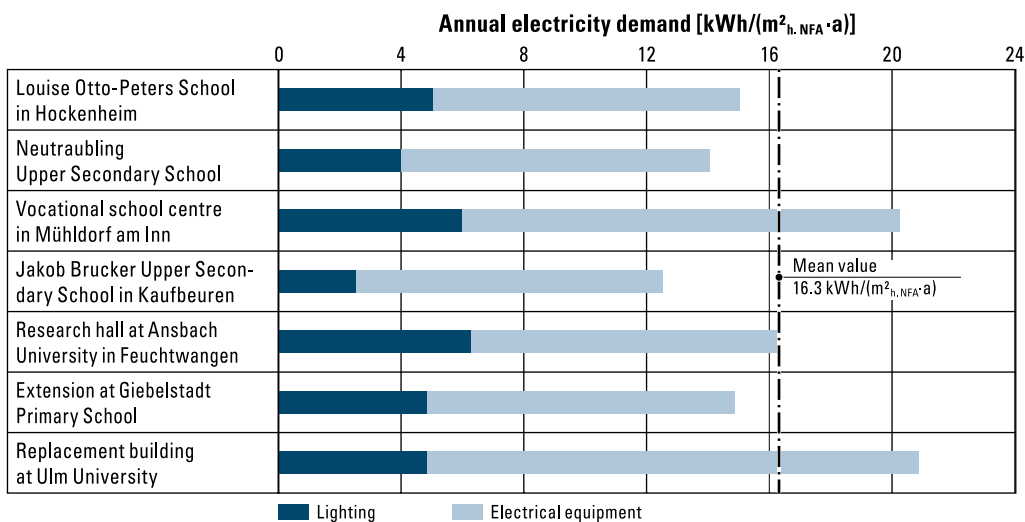

Figure 87: Annual final energy demand for lighting and appliances  
Chart: Fraunhofer IBP

**Photovoltaics**

	Area of photovoltaic system						
	Louise Otto-Peters School in Hockenheim	Neutraubling Upper Secondary School	Vocational school centre in Mühldorf am Inn	Jakob Brucker Upper Secondary School in Kaufbeuren	Research hall at Ansbach University in Feuchtwangen	Extension at Giebelstadt Primary School	Replacement building at Ulm University
On top of EHP building	1,048 m <sup>2</sup>	1,380 m <sup>2</sup>	697 m <sup>2</sup>	1,787 m <sup>2</sup>	246 m <sup>2</sup>	323 m <sup>2</sup>	1,107 m <sup>2</sup>
On top of other buildings*		1,023 m <sup>2</sup>	1,867 m <sup>2</sup>				773 m <sup>2</sup>
Total	1,048 m <sup>2</sup>	2,403 m <sup>2</sup>	2,563 m <sup>2</sup>	1,787 m <sup>2</sup>	246 m <sup>2</sup>	323 m <sup>2</sup>	1,880 m <sup>2</sup>
Visualisation of the areas							

\*) within the property boundaries of the Efficiency House Plus model project

Figure 88: PV installations on the seven educational buildings (planned or existing)  
Chart: Fraunhofer IBP

When designing an Efficiency House Plus building, it is necessary to weigh up the merits of minimising energy demand (e.g. by increasing thermal protection) against the size and output of the solar panels that could potentially be installed. In three of the seven model projects, PV systems are to be installed not just on the roof of the Efficiency House Plus buildings themselves, but also on roof areas belonging to other buildings on the same plot. Figure 88 shows the PV installations on all seven pilot projects (planned or existing). Analysis of the model projects reveals that – on average – the designs allow for around 0.3 square metres of PV installations per square metre of heated net floor area. The peak outputs of the PV systems are expected to vary between 34 and 89 Wp per

$m^2_{heatedNFA}$ , with an average figure of around 51 Wp per  $m^2_{heatedNFA}$ . Since the extension at Giebelstadt Primary School and the research hall at Ansbach University in Feuchtwangen are constructed over fewer floors (1–1.5) than the other model projects, a higher proportion of PV panels and therefore a higher peak output per square metre of heated net floor area can be achieved for these two projects. In accordance with the degree of self-use calculated in accordance with DIN V 18599, between 40% and 75% of the electricity generated by the PV systems is used by the Efficiency House Plus buildings themselves. This corresponds to an annual energy figure of between 15 and 29 kWh per  $m^2_{heatedNFA}$ .

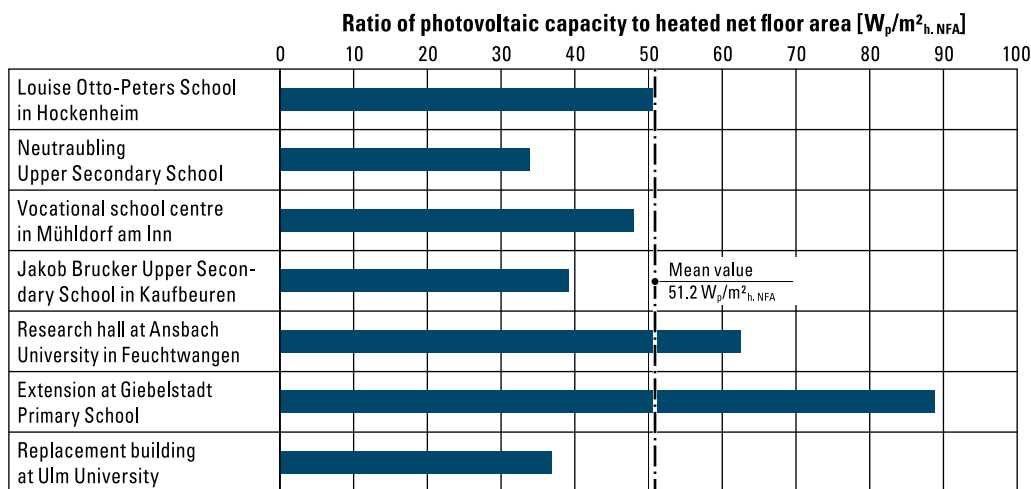

Figure 89: Installed peak outputs of PV systems in relation to heated net floor area  
Chart: Fraunhofer IBP

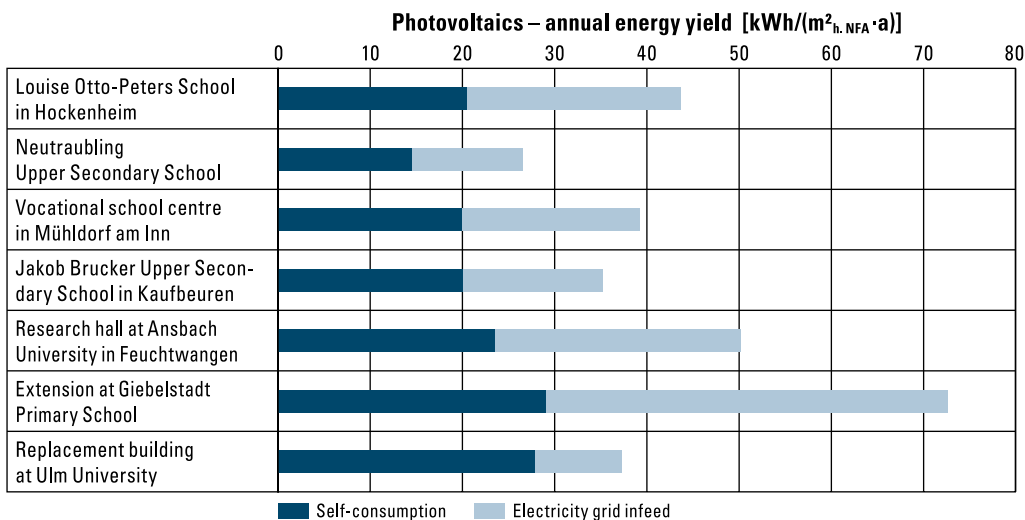

Figure 90: Proportion of electricity generated locally by PV systems that is used within the building or fed into the grid  
Chart: Fraunhofer IBP

**Final energy balance**

The final energy demand by the educational buildings for heating and cooling, domestic hot water and auxiliary energy as well as lighting and appliances (calculated on a normative basis during the planning process) is compared against the final energy generated locally from renewable sources over the course of a year, in the form of an energy balance. According to the Efficiency House Plus standard, the energy generated within the boundaries of the plot must exceed the energy consumed. The calculated annual final energy demand for the educational buildings varies between 26 and 68 kWh per m<sup>2</sup><sub>heatedNFA</sub> per year. All of the buildings use large-scale PV systems to generate electricity. The replacement building at Ulm

University also uses the return flow from the district cooling network as a source of renewable heat, thereby lowering the temperature of the return flow. The energy withdrawn for the purpose of lowering the return flow temperature is credited to the building as a renewable energy yield, since the corresponding amount of energy no longer needs to be generated by the network’s central cooling unit. The annual final energy yield from renewables for the model projects (calculated on a normative basis) ranges from 30 to 73 kWh per m<sup>2</sup><sub>heatedNFA</sub> per year. On average, the calculated final energy surplus is around 9 kWh per m<sup>2</sup><sub>heated.NFA</sub> per year.

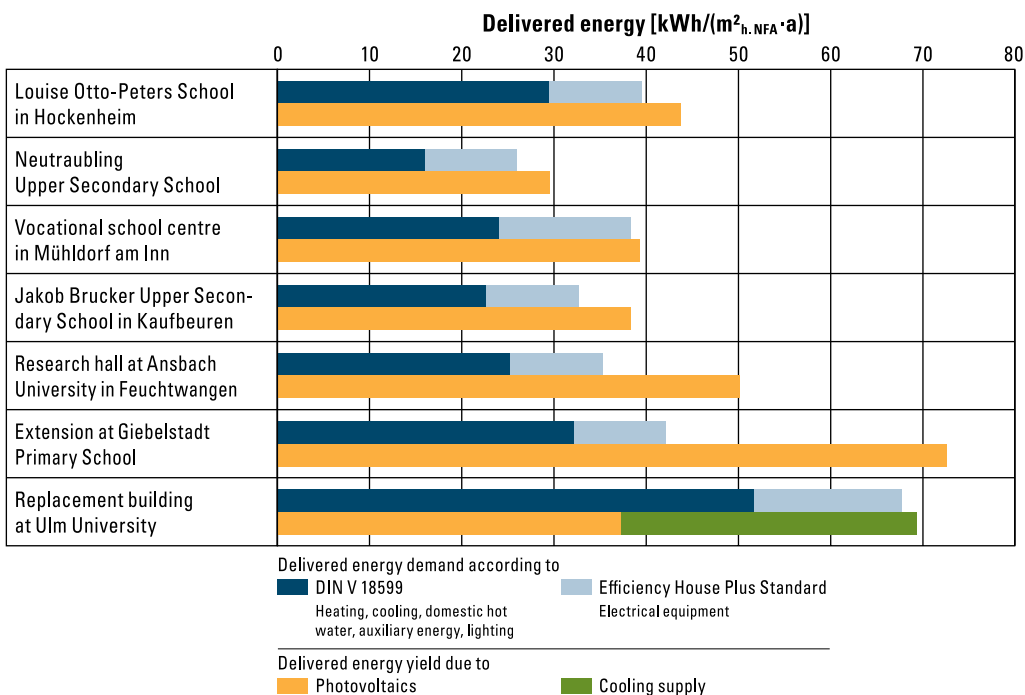

Figure 91: Calculated annual final energy – demand and yield  
Chart: Fraunhofer IBP



**Primary energy balance**

The primary energy balance compares a building’s primary energy demand against its primary energy credit over the course of a year. The primary energy demand or primary energy credit is obtained by multiplying the final amount of energy from energy carriers (either supplied from the exterior or transferred to the exterior) by the corresponding primary energy factor. Primary energy is used to quantify not only the final energy quantity, but also the process chains of an energy carrier situated upstream or downstream of the energy balance boundary under investigation. This ensures that different energy carriers can be compared against each other. The Efficiency House Plus standard requires not only a surplus of final energy generated using renewables, but also a surplus resulting from primary energy credits on the relevant plot.

Four of the seven model projects use electricity as the sole energy carrier. The remaining three model projects use local or district

heating, district cooling or natural gas. The annual primary energy demand calculated the educational buildings ranges from 18 to 34 kWh per m<sup>2</sup><sub>heatedNFA</sub> per year.

The primary energy credit assesses the energy carriers transferred outside the boundary of the energy balance. The electricity from the PV systems fed into the grid is taken into account on the basis of a primary energy factor of 2.8 for the displacement mix. The Buildings Energy Act reduced this factor to that of the average general electricity mix. In the case of the replacement building at Ulm University, the feed-in of cooling into the district cooling network is credited in addition to the feed-in of PV electricity into the grid. The primary energy credit calculated for the Efficiency House Plus educational buildings as a result of grid feed-ins is between 38 and 123 kWh per m<sup>2</sup><sub>heatedNFA</sub> per year. On average, the anticipated primary energy surplus is around 39 kWh per m<sup>2</sup><sub>heatedNFA</sub> per year.

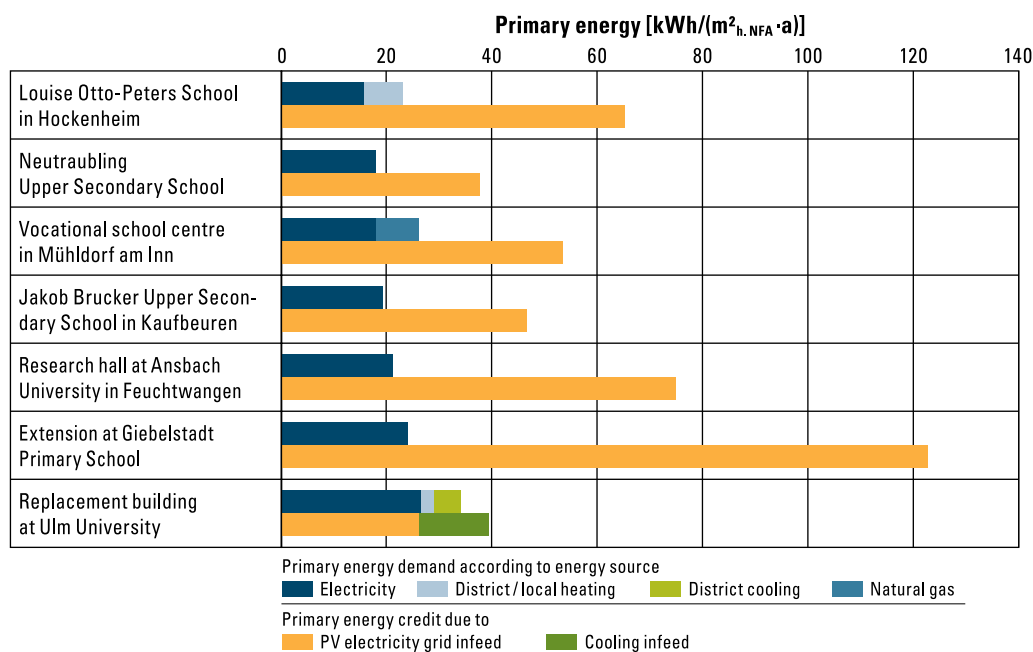

Figure 92: Primary energy – demand and credit due to grid feed-in  
Chart: Fraunhofer IBP

**CO<sub>2</sub> equivalent**

The greenhouse gas emissions caused by energy consumption in buildings (equivalent CO<sub>2</sub> emissions) can be calculated in CO<sub>2</sub> equivalents. Similarly, equivalent CO<sub>2</sub> reduction can be calculated on the basis of the surplus renewable energy generated locally (e.g. using PV electricity) that is fed into public energy grids. If the balance (equivalent CO<sub>2</sub> emissions minus reduction) is negative, the building helps to reduce emissions of greenhouse gases in Germany. The annual cumulative reduction resulting from the model projects has been calculated as 73 tonnes of CO<sub>2</sub> equivalent per year. The annual greenhouse gas reduction resulting from the individual model projects is indicated on each project’s title page.

## Motives

With the seven model projects funded by the Federal Ministry of the Interior, Building and Community a range of different educational buildings are being built to the Efficiency House Plus standard for the very first time in Germany. As part of the accompanying research, the building owners involved in the projects were asked about their motives for complying with a standard that imposes such stringent energy-related and environmental requirements.

Many of them cited a desire to save energy and money while operating their buildings – with the attendant environmental benefits – as reasons for using the Efficiency House Plus standard. A number of building owners were also motivated by the belief that cities, towns and municipalities should play an exemplary role by constructing educational buildings that generate more energy locally from renewable sources than they consume in operation.

### Statements



Frank Tuschla, Department of Technology, Assets and Construction Baden-Württemberg, Ulm Office, on the replacement building at Ulm University

The fact that the replacement building at Ulm University is being built to the Efficiency House Plus standard makes it a prototype in the truest sense of the word, and a flagship construction project for the Federal State (*Land*).



Tanja Schweiger, Chief Administrator of the Rural District of Regensburg, on Neutraubling Upper Secondary School

Making the most of new energy-saving opportunities when constructing or renovating buildings is a task for society as a whole. According to an efficiency audit carried out for our upper secondary school, the extra costs of complying with the Efficiency House Plus standard – €1 million – will pay for themselves after just five and a half years, since operating costs will drop by €200,000. The district council (*Kreistag*) voted unanimously in favour of the measure thanks to its sustainable concept. By complying with these energy standards when renovating its existing building stock or constructing new buildings, the Rural District of Regensburg hopes to play an exemplary role and to encourage private and public building owners to opt for energy-efficient building designs.



Stefan Schirm, Technical Construction Department of the Municipality of Giebelstadt, on the extension at Giebelstadt Primary School

We opted for the Efficiency House Plus standard with the aim of reducing ongoing costs and conserving natural resources by saving energy. The flagship renovation of the existing building means that the entire educational building is a showcase for the region.

## Lessons learned

### Challenges

Achieving the Efficiency House Plus standard involves meeting more stringent requirements in terms of planning and execution. With a view to analysing specific issues that had arisen, the project participants were asked to identify any special challenges they had faced in connection with planning or executing the construction process for an Efficiency House Plus building. The feedback received in response to this survey made it clear that the significance of integrated planning approaches and project coordination increases in step with the energy demand of the relevant building. In addition, all of the Efficiency House Plus educational buildings complete a two-year measurement period during which operation of the building is optimised. The teams of measuring technicians were already able to compile a set of initial lessons learned. The following experiences and findings from the model projects may help to ensure that the challenges facing future projects can be identified at an early stage and examined systematically, thereby reducing their impact.

### Project coordination and planning

- The decision to construct or renovate an educational building to the Efficiency House Plus standard should be made at an early stage in proceedings. Decisions at a later stage involve costly alterations.
- Building users and specialist planners must be involved in the planning process from early on. Stringent energy-related requirements have an impact on all specialist disciplines and many of the trades involved in constructing a building. The discipline-specific requirements to be met by the building should be made clear at an early stage.
- The requirements that must be met in order to comply with the Efficiency House Plus standard must be clear to all the parties involved. The processes, scope of services and interfaces resulting from the requirements imposed by the standard should be specified by the planning team, and compliance should be monitored on a continuous basis.
- All planning alterations should be documented clearly as a basis for adequate reviews of the goals that have been set and the measures that have been implemented.
- Attention to detail is vitally important during the planning process. Some of the specialist planners surveyed recommended 3D planning.

### Monitoring

- A monitoring team should be involved as early as possible during the planning phase to avoid major problems when integrating the measurement technology or cumbersome solutions that increase costs.
- The measurement data must be made available to the monitoring team promptly, in the form of unprocessed raw data. Interim processing by the building owners (municipalities) or third parties can be the source of errors and delays, and should be avoided.
- To avoid confusion, the field labels used for data should be unambiguous and easy for third parties to understand. If any of the sensors are modified, the changes must be immediately documented and notified to all participants.
- Potential causes of errors when analysing measured data include the following:
  - failure to communicate and review deviations from the measurement concept, e.g. use of different meters or configurations using different measurement units or dimensions;
  - sensors (e.g. for building control systems) that are not calibrated;
  - incorrect installation of meters, e.g. mixed up feed and return sensors;
  - prolonged outage of measurement sensors, data transmission or the data server; major data losses resulting from such events can be avoided by taking manual readings of the most important meters on a regular basis;
  - inappropriate measurement intervals: if measurements are not taken often enough, the measurement data will be crude and it will be impossible to evaluate dynamic behaviour; if measurements are taken too often, it may not always be possible to transmit the large quantities of data that are generated, and evaluating them becomes a more complex task.

## Evaluation of initial monitoring data

Once the construction phase of a new build or renovation has been completed, the usage phase commences, during which the energy concept must prove its value during practical operation. Monitoring will therefore be implemented during at least two heating periods for a duration of at least two years in the case of all of the model projects. The purpose of monitoring is to validate the energy concept in general terms and also to document the impacts of operational optimisation and other adjustments during the first months of using the building, e.g. the extent to which users (pupils, apprentices, students, teachers, trainers, professors, etc.) have become accustomed to the new teaching and learning environment.



Figure 93: Electrical inverter with power display  
Photograph: Fraunhofer IBP



Figure 94: Manual recording of measurements  
Photograph: Fraunhofer IBP



Figure 95: Measurement server  
Photograph: Fraunhofer IBP

Various aspects relating to the assessment and operational optimisation can be recorded, queried and analysed within the framework of technical and social scientific monitoring. Technical monitoring measures serve as a basis for checking whether the energy demand values and amounts of energy generated that were previously calculated during the planning phase are corroborated by the figures recorded during actual operation. The sensors for the monitoring project are installed in parallel to the construction phase. Since the buildings are typically equipped with building control systems, the data are recorded using these systems. However, not all of the measuring points included in the building control systems are required for validation measurements. Equally, sensors are required for validation purposes that are irrelevant for control and adjustment purposes. The measurement accuracy of the sensors used is a particularly significant factor, since the requirements imposed in the field

of building control systems are often less stringent (no calibration, higher tolerance ranges, etc.).

Data are transmitted to the monitoring teams involved on a continuous basis, but must be subject to constant supervision and checks to ensure that no data losses occur, or that any losses that do occur are identified and eliminated promptly. Supplementary manual read-outs of the most important meters are recommended to ensure that there are no gaps in the data used to produce the energy balance. The educational buildings built to the Efficiency House Plus standard were designed not only to minimise consumption and achieve an energy surplus, but also to provide outstanding levels of comfort for their users. To assess whether this goal had been achieved, the respective monitoring teams will record indoor air temperatures in representative rooms and, in certain buildings, also measure air quality and lighting conditions.

The measurement data for the seven educational buildings built to the Efficiency House Plus Standard were evaluated by:

ina Planungsgesellschaft mbH,  
Darmstadt



Planungsgesellschaft mbH  
ein Spin-off der TU Darmstadt

Louise Otto-Peters School  
in Hockenheim  
Research hall at Ansbach  
University of Applied Sciences  
in Feuchtswangen

Dresden University of Technology,  
Institute of Power Engineering in collaboration  
with EA Systems Dresden GmbH



TECHNISCHE  
UNIVERSITÄT  
DRESDEN



EA Systems Dresden  
optimizing your energy applications

Neutraubling Upper Secondary School  
Jakob Brucker Upper Secondary School  
in Kaufbeuren  
Extension at Giebelstadt Primary School

Rosenheim  
Technical University  
of Applied Sciences

Technische  
Hochschule  
Rosenheim



Vocational school centre  
in Mühldorf am Inn

Fraunhofer Institute for Building  
Physics (IBP), Department  
of Energy Efficiency and Indoor  
Climate, Holzkirchen



Fraunhofer

IBP

Replacement building  
at Ulm University

**Example 1: Research hall at Ansbach University of Applied Sciences in Feuchtwangen**

The monitoring phase commenced in January 2020, after the research hall had been occupied and an adjustment period was completed. The measuring project is being carried out by ina Planungsgesellschaft, and is scheduled to run until the end of 2021. The building’s measurement set-up was designed in such a way that the calculated proportions of the energy balance could be compared against the measured proportions. Figure 96 shows a simplified

overview of the measurement concept. In addition to the electricity generated by the PV system, the energy consumption for operation of the building services (heating, cooling, domestic hot water, ventilation and lighting) and electrical equipment, the air temperatures of the individual rooms (research hall, seminar room, office, etc.) and weather data at the building location are recorded using data loggers.

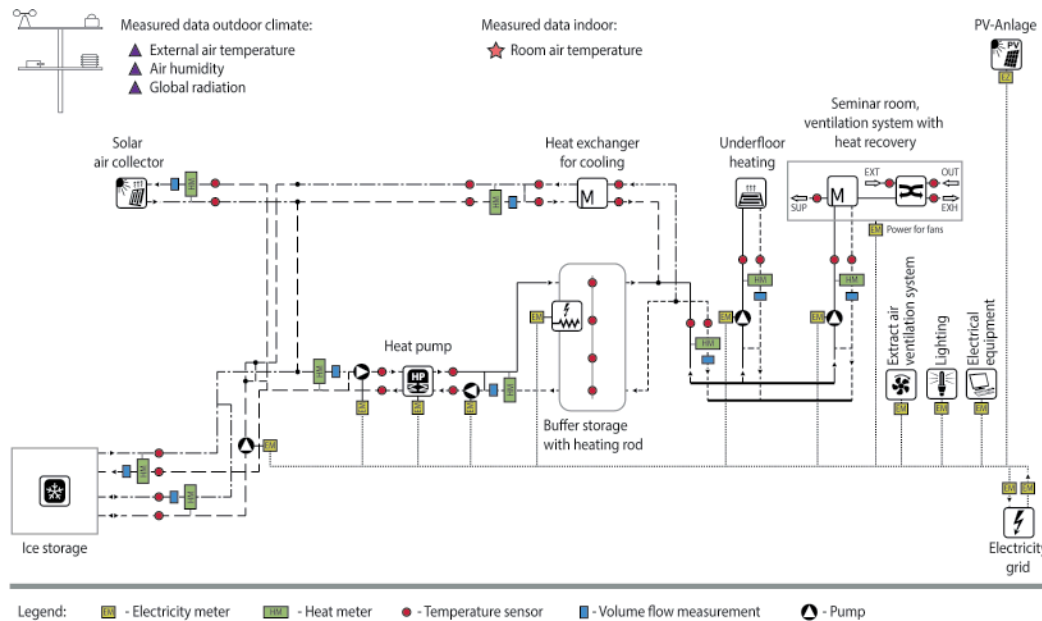

Figure 96: Measurement concept for the research hall in Feuchtwangen  
Diagram: Fraunhofer IBP

Figure 97 shows the cumulated final energy values over the course of a year. A comparison of final energy consumption against final energy yield immediately reveals whether the building achieves a positive final energy balance at the end of the year, i.e. whether the amount of energy generated exceeds the amount consumed for operation and use. Measurements are available since January 2020 for the research hall at Ansbach University of Applied Sciences, and the measured values for January to Oktober 2020 have been compared against the target values. The consumption shown inclu-

des operation of the building services systems, lighting and electrical equipment in the building; overall, it is very similar to the values calculated previously. Different trends are, however, revealed by drilling down to the individual shares of consumption. The amount of energy consumed for the operation of building services systems and for lighting was less than or roughly equal to the demand values previously calculated in all four months, but the amount of energy consumed for electrical equipment was significantly higher (around 70 %) than predicted.

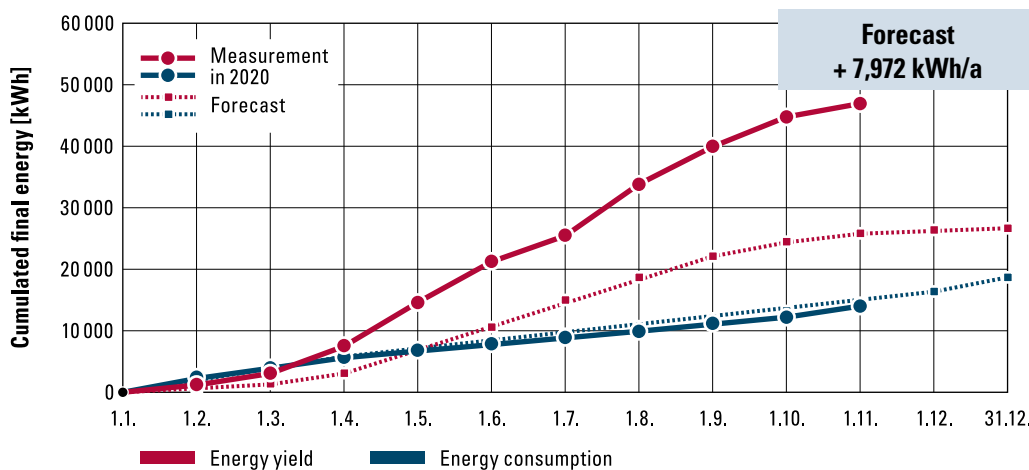

Figure 97: Monthly comparison of the energy values calculated and measured in 2020 for the research hall in Feuchtwangen.  
Chart: Fraunhofer IBP

The PV system on the roof of the research hall generated almost twice as much electricity as planned. This discrepancy can be attributed to differing framework conditions for planning and measurement. The PV yield was calculated at the planning stage in accordance with DIN V 18599 (2011), using the standard value for monocrystalline PV systems and the solar radiation data for the climate reference location of Potsdam provided in this standard.

According to the manufacturer’s specifications, the output of the PV system is higher than the standard value used for calculations. Solar radiation at the Feuchtwangen site is also higher than the values for the climate reference location. During the first few months of monitoring, the figures for the building demonstrated a clear trend towards an energy surplus in the annual final energy balance.

**Example 2: Extension at Giebelstadt Primary School**

The extension at Giebelstadt Primary School is monitored by Dresden University of Technology in collaboration with EA Systems Dresden GmbH. This part of the building was put into operation in late 2018, making it possible to collect a full year’s worth of measurement data for the primary school. An online platform provides access for all project participants to the measurement data recor-

ded for the building and for the systems engineering. In addition to the electricity generated by the PV system and the energy consumed to operate the building services systems, lighting and electrical equipment, air temperatures are measured in two representative rooms and weather data are collected at the building location.

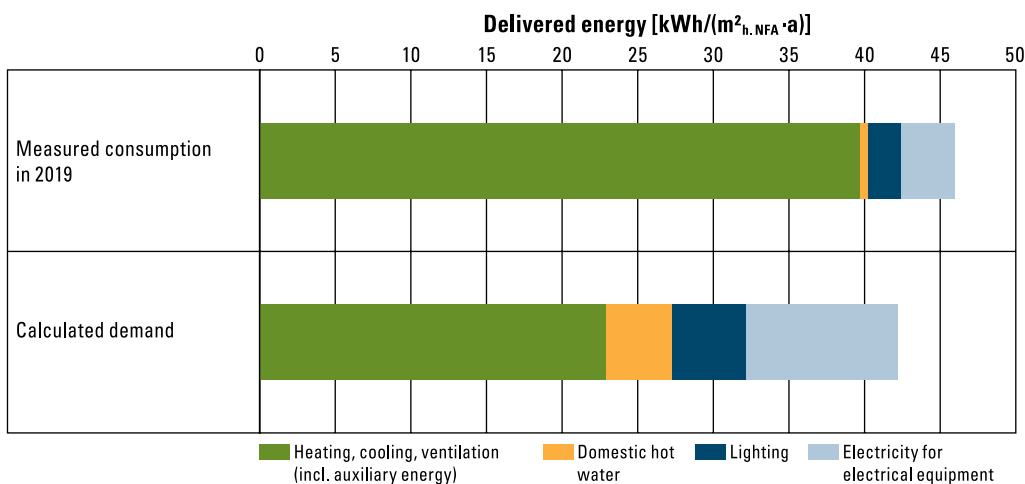

Figure 98: Comparison of the final energy demand according to calculations and the final energy demand measured in 2019 for the extension at Giebelstadt Primary School  
Chart: Fraunhofer IBP

Figure 98 shows the calculated final energy demand and the building’s final energy consumption in 2019. In 2019, the extension consumed a total of 46 kWh per m<sup>2</sup><sub>heatedNFA</sub> per year) of electricity. Overall, the consumption values measured for 2019 are roughly the same as the target values of 42 kWh per m<sup>2</sup><sub>heatedNFA</sub> per year. Different trends are, however, revealed by drilling down to the individual shares of consumption. The consumption of energy for heating, cooling and ventilation exceeds the calculated demand values (74 % higher), but the consumption of electricity for lighting, domestic hot water and electrical equipment is significantly lower (55 % to 88 %) than the previous calculations. This discrepancy can be attributed to differing framework conditions for planning and measurement. The extension’s heat pump was used to supply an existing building within the school complex on a temporary basis due to a technical malfunction. The heat supplied to the existing building is included in the measured values but not in the target values. The consumption of electricity for lighting, domestic hot water and electrical equipment is below the target values. Planning was based on the assumption that the usage profile for classrooms described in DIN V 18599 would apply (period of use between 08:00 and 15:00). Since the building is used to supervise pupils at lunchtime, the rooms are predominantly used from late morning onwards. The fact that they are

not used until later in the day and that they are used for a relatively short period has an impact on the amount of electricity consumed. Operation of the building systems in 2019 was influenced by the efforts undertaken by the planning and monitoring teams to optimise these systems with a view to reducing the consumption of electricity for heating, cooling and ventilation of this part of the building.

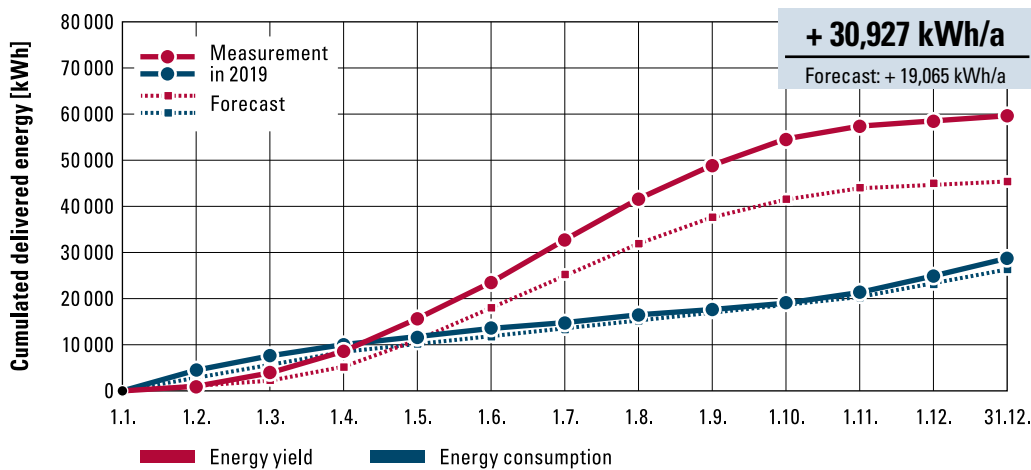

Figure 99: Monthly comparison of the final energy values according to calculations and the final energy values measured in 2019 for the extension at Giebelstadt Primary School  
Chart: Fraunhofer IBP

Based on the usage profile and the overall energy concept, which includes not only a newly constructed PV system and energy-efficient plant components, but also a building envelope of high thermal quality, it was possible for Giebelstadt Primary School to achieve a positive final energy balance from March 2019 onwards. Figure 99 shows the evolution of cumulated final energy values over the

course of 2019. During the first year of measurements, the amount of electricity generated by the extension’s PV system was significantly more than the amount consumed for the operation and use of this part of the building. It was possible to use the surplus electricity in the primary school’s existing buildings.



Figure 100: Evaluation of the air temperature in a common room within the extension at Giebelstadt Primary School for the period between January 2019 and July 2020, on the online platform provided by Dresden University of Technology  
Source: Dresden University of Technology

The respective teams of measuring technicians analyse the measurement data, minimise energy consumption and optimise indoor comfort. By way of an example, Figure 100 illustrates how the online platform of Dresden University of Technology can be used to monitor the indoor air temperature of a common room within the extension at Giebelstadt Primary School. Monitoring of this kind makes it possible to determine whether it is too cold or too hot in the rooms during the different seasons.

### List of abbreviations

A/V	building envelope factor, ratio between the building's exterior surface area and its volume
BBR	Bundesamt für Bauwesen und Raumordnung (Federal Office for Building and Regional Planning)
BBSR	Bundesinstitut für Bau-, Stadt- und Raumforschung (Federal Institute for Research on Building, Urban Affairs and Spatial Development)
BCA	building component activation
BMI	Bundesministerium des Innern, für Bau und Heimat (Federal Ministry of the Interior, Building and Community)
BW	Baden-Württemberg
C	cooling
CO <sub>2</sub>	carbon dioxide
EER	Energieeffizienz und Raumklima (Energy Efficiency and Indoor Climate, Department of the Fraunhofer Institute for Building Physics)
EnEV	Energieeinsparverordnung (Energy Saving Ordinance)
EXH	exhaust air
EXT	extract air
GEG	Gebäudeenergiegesetz (Buildings Energy Act)
H	heating
IBP	Fraunhofer-Institut für Bauphysik (Fraunhofer Institute for Building Physics, IBP)
LED	light-emitting diode
NFA	net floor area
OUT	outside air
PV	photovoltaics
RFH	room floor heating
SEG	segment
SUP	supply air

### Units

cm	centimetre
kW	kilowatt
kWh	kilowatt-hour
kWh per year	kilowatt-hour per year
kWh per m <sup>2</sup> <sub>heatedNFA</sub> per year	kilowatt-hour per square metre of heated net floor area per year
kW <sub>p</sub>	kilowatt peak
m <sup>2</sup>	square metre
m <sup>3</sup>	cubic metre
t CO <sub>2</sub> per year	tonne of carbon dioxide per year
W per m <sup>2</sup> per Kelvin	watt per square metre per Kelvin
Wp/m <sup>2</sup> <sub>heatedNFA</sub>	watt peak per square metre of heated net floor area

### Useful links

Federal Ministry of the Interior, Building and Community

→ [www.bmi.bund.de](http://www.bmi.bund.de)

Federal Institute for Research on Building, Urban Affairs and Spatial Development within the Federal Office for Building and Regional Planning

→ [www.bbsr.bund.de](http://www.bbsr.bund.de)

"Future Building" innovation programme

→ [www.zukunftbau.de](http://www.zukunftbau.de)

Fraunhofer Institute for Building Physics (IBP), Department of Energy Efficiency and Indoor Climate

→ [www.ibp.fraunhofer.de/eer](http://www.ibp.fraunhofer.de/eer)

Efficiency House Plus calculator

→ [www.effizienzhaus-plus-rechner.de](http://www.effizienzhaus-plus-rechner.de)

Efficiency House Plus initiative

→ [www.zukunftbau.de/effizienzhaus-plus/](http://www.zukunftbau.de/effizienzhaus-plus/)



## Publications

The publications of the Federal Institute for Research on Building, Urban Affairs and Spatial Development within the Federal Office for Building and Regional Planning and the Federal Ministry of the Interior, Building and Community are available to download free of charge. → [www.zukunftbau.de/publikationen/](http://www.zukunftbau.de/publikationen/)

Printed copies can also be ordered free of charge.



### Efficiency House Plus – Planning Recommendations

The brochure was produced on behalf of the Federal Government and is targeted at architects, specialist planners and building owners. Publication year 2019



### What makes an Efficiency House Plus?

This brochure provides information on the innovative building standard and the latest outcomes from the network. Publication year 2018

## List of figures and picture credits

### Title page

Rows of images from left to right, starting at the top:

- Louise Otto-Peters School, Hockenheim, Dorothea Burkhardt, Heidelberg
- Neutraubling Upper Secondary School, Architekturbüro Winkler-Architekten, Wörth an der Donau
- Vocational School Centre in Mühldorf am Inn, ARIS Architekten PartG mbH, Kraiburg am Inn
- Jakob Brucker Upper Secondary School, Kaufbeuren, köhler architekten + beratende ingenieure, Gauting
- Research hall at Ansbach University of Applied Sciences in Feuchtwangen, Dr Reinhard Reck, Dinkelsbühl
- Extension at Giebelstadt Primary School, Haase & Bey Architekten PartG mbB, Karlstadt
- Replacement building at Ulm University, SPREEN ARCHITEKTEN Partnerschaft mbB, Munich

### Introduction

Page 8, Figure 1 – Overview map:  
– Fraunhofer Institute for Building Physics (IBP), Stuttgart

### Definition of Efficiency House Plus

Page 9, Figure 2 – Energy passport, certificate:  
– Fraunhofer Institute for Building Physics (IBP), Stuttgart

### Louise Otto-Peters School in Hockenheim

Double page 10/11, Figure 3 – Photograph of assembly hall:  
– Rhine-Neckar District

Page 12, Figure 4 – Photograph of view from the south-west:

– Dorothea Burkhardt, Heidelberg

Page 12, Figure 5 – Site plan and

Page 13, Figure 6 – Ground floor layout plan:

– Roth.Architekten.GmbH, Schwetzingen

Page 13, Figures 7, 8, 9 – Photographic impressions of the school:

– Dorothea Burkhardt, Heidelberg (Figures 7 and 8)

– Rhine-Neckar District (Figure 9)

Page 14, Figure 10 – Diagram showing a cross-section of the building services:

– Fraunhofer Institute for Building Physics (IBP), Stuttgart

Page 14, Figures 11, 12, 13 – Photographs of systems engineering:

– Ingenieurbüro Willhaug GmbH, Mosbach (Figures 11 and 13)

– Rhine-Neckar District (Figure 12)

Page 15, Figure 14 – Diagram showing the final energy surplus:

– Fraunhofer Institute for Building Physics (IBP), Stuttgart

### Upper Secondary School in Neutraubling

Double page 16/17, Figure 15 – Photograph of staffroom,

Page 18, Figure 16 – Visualisation of overall complex,

Page 18, Figure 17 – Site plan,

Page 19, Figure 18 – Outline plan of ground floor and

Page 19, Figures 19 and 20 – Photographs of the school:

– Architekturbüro Winkler-Architekten, Wörth an der Donau

Page 19, Figure 21 – Photograph of kitchenette:

– Neutraubling Upper Secondary School

### List of figures and picture credits – continued

Page 20, Figure 22 – Diagram showing a cross-section of the building services:

– Fraunhofer Institute for Building Physics (IBP), Stuttgart

Page 20, Figures 23, 24, 25 – Photographs of systems engineering:

– Neutraubling Upper secondary school

Page 21, Figure 26 – Diagram showing the final energy surplus:

– Fraunhofer Institute for Building Physics (IBP), Stuttgart

#### Vocational school centre in Mühldorf am Inn

Double page 22/23, Figure 27 – Photograph of assembly hall,

Page 24, Figure 28 – Photograph of view from the south:

– ARIS Architekten PartG mbH, Kraiburg am Inn

Page 24, Figure 29 – Site plan and

Page 25, Figure 30 – Ground floor layout plan:

– ARGE Schmuck-Anglhuber Architekten, Munich/Kraiburg

Page 25, Figures 31 and 32 – Photographic impressions of the school:

– ARIS Architekten PartG mbH, Kraiburg am Inn

Page 26, Figure 33 – Diagram showing a cross-section of the building services:

– Fraunhofer Institute for Building Physics (IBP), Stuttgart

Page 26, Figures 34 to 36 – Photographs of building services:

– COPLAN AG, Mühldorf am Inn

Page 27, Figure 37 – Diagram showing the final energy surplus:

– Fraunhofer Institute for Building Physics (IBP), Stuttgart

#### Jakob Brucker Upper Secondary School in Kaufbeuren

Double page 28/29, Figure 38 – Photograph of the atrium gallery on the top floor:

– mse architekten gmbh, Kaufbeuren

Page 30, Figure 39 – Visualisation of the south side of the new build,

Page 30, Figure 40 – Site plan and

Page 31, Figure 41 – Ground floor layout plan:

– köhler architekten + beratende ingenieure, Gauting

Page 31, Figures 42 to 44 – Photographic impressions of the school:

– Town of Kaufbeuren (Figures 42 and 43)

– mse architekten gmbh, Kaufbeuren (Figure 44)

Page 32, Figure 45 – Diagram showing a cross-section of the building services:

– Fraunhofer Institute for Building Physics (IBP), Stuttgart

Page 32, Figures 46 to 48 – Photographs of building services:

– Town of Kaufbeuren (Figures 46 and 47)

– Güttinger Ingenieure, Kempten (Figure 48)

Page 33, Figure 49 – Diagram showing the final energy surplus:

– Fraunhofer Institute for Building Physics (IBP), Stuttgart

#### Research hall at Ansbach University of Applied Sciences in Feuchtwangen

Double page 34/35, Figure 50 – Photographic view of the hall:

– City of Feuchtwangen

Page 36, Figure 51 – Photograph of the view from the south-west:

– Dr Reinhard Reck, Dinkelsbühl

Page 36, Figure 52 – Site plan and

Page 37, Figure 53 – Ground floor layout plan:

– HEF – Holzinger Eberl Fürhäußer Architekten, Ansbach

Page 37, Figures 54 to 56 – Photographs in the research hall:

– Seminar room (Figure 54) Sequence of still images from

the virtual building tour available via the “Virtual Reality App”

provided by the Centre for Energy, Construction, Architecture

and the Environment (*Zentrum für Energie, Bauen, Architektur*

*und Umwelt*, ZEBAU), Hamburg

– City of Feuchtwangen (Figures 55 and 56)

Page 38, Figures 58 to 60 – Photographs of plant technology:

– City of Feuchtwangen

Page 38, Figure 57 – Diagram showing a cross-section of

the building services:

– Fraunhofer Institute for Building Physics (IBP), Stuttgart

Page 39, Figure 61 – Diagram showing the final energy surplus:

– Fraunhofer Institute for Building Physics (IBP), Stuttgart

#### Extension at Giebelstadt Primary School

Double page 40/41 Figure 62 – Photograph of the view from the south-east,

Page 42, Figure 63 – Photograph of the view from the south,

Page 42, Figure 64 – Site plan,

Page 43, Figure 65 – Outline plan of ground floor,

Page 43, Figures 66 to 68 – Photographic impressions of the school,

Page 44, Figures 70 to 72 – Photographs of plant technology:

– Haase & Bey Architekten PartG mbB, Karlstadt

Page 44, Figure 69 – Diagram showing a cross-section

of the building services and

Page 45, Figure 73 – Diagram showing the final energy surplus:

– Fraunhofer Institute for Building Physics (IBP), Stuttgart

#### Replacement building at Ulm University

Double page 46/47, Figure 74 – Photograph of the view from the south and

Page 48, Figure 75 – Visualisation of the view from the north-west:

– SPREEN ARCHITEKTEN Partnerschaft mbB, Munich

Page 48, Figure 76 – Site plan:

– Koeber Landschaftsarchitektur GmbH, Stuttgart

Page 49, Figure 77 – Ground floor layout plan

– Assets and Construction Baden-Württemberg, Ulm Office

Page 49, Figures 78 to 80 – Photographs of the construction phase:

– SPREEN ARCHITEKTEN Partnerschaft mbB, Munich

Page 50, Figure 81 – Diagram showing a cross-section of the

building services and

Page 51, Figure 82 – Diagram showing the final energy surplus:

– Fraunhofer Institute for Building Physics (IBP), Stuttgart

#### Cross-evaluation of planning

Pages 52 to 57, Figures 83 to 92 – Diagrams:

– Fraunhofer Institute for Building Physics (IBP), Stuttgart

#### Evaluation of initial monitoring data

Page 60, Figures 93 to 95 – Photographs of monitoring and

Pages 61 to 63, Figures 96 to 99 – Diagrams:

– Fraunhofer Institute for Building Physics (IBP), Stuttgart

Page 63, Figure 100 – Screenshot of the online platform

– Dresden University of Technology



