

LOW EXERGY SYSTEMS FOR
HEATING AND COOLING OF BUILDINGS

GUIDEBOOK

SUMMARY REPORT



HEATING AND COOLING WITH FOCUS ON INCREASED ENERGY EFFICIENCY AND IMPROVED COMFORT



Edited by Mia Ala-Juusela

Heating and Cooling with Focus on Increased Energy Efficiency and Improved Comfort

Guidebook to IEA ECBCS Annex 37
Low Exergy Systems for Heating and Cooling of Buildings
Summary Report



ISBN 951-38-6488-X (soft back ed.)
ISSN 1235-0605 (soft back ed.)
ISBN 951-38-6489-8(<http://www.vtt.fi/inf/pdf/>)
ISSN 1455-0865 (<http://www.vtt.fi/inf/pdf/>)
Copyright © VTT 2004

JULKAISUJA – UTGIVARE – PUBLISHER
VTT, Vuorimiehentie 5, PL 2000, 02044 VTT
puh. vaihde (09) 4561, faksi (09) 456 4374

VTT, Bergsmansvägen 5, PB 2000, 02044 VTT
tel. växel (09) 4561, fax (09) 456 4374

VTT Technical Research Centre of Finland, Vuorimiehentie 5, P.O.Box 2000, FIN-02044 VTT, Finland
phone internat. + 358 9 4561, fax + 358 9 456 4374

VTT Rakennus- ja yhdyskuntatekniikka,
Lämpömiehenkuja 2, PL 1800, 02044 VTT, puh. vaihde (09) 4561

VTT Bygg och transport,
Värmemansgränden 2, PB 1800, 02044 VTT, tel. växel (09) 4561

VTT Building and Transport,
Lämpömiehenkuja 2, P.O.Box 1800, FI-02044 VTT, Finland, phone internat. + 358 9 4561

Edited by Mia Ala-Juusela, VTT, Finland
Technical editing by Auli Rautakivi, VTT, Finland
Layout Auli Rautakivi & Mia Ala-Juusela, VTT based on the template of Tuija Karppanen.

Edita Prima Oy, Helsinki 2004

ABSTRACT

The Summary Report and Guidebook summarise the work of the LowEx cooperation. An other result of the LowEx cooperation was the funding of the International Society for Low Exergy Systems in Buildings (LowExNet). LowEx, the international research programme for Low Exergy Systems for Heating and Cooling of Buildings, is part of the International Energy Agency's (IEA) Implementing Agreement Energy Conservation in Buildings and Community Systems (ECBCS). The aim of the programme was to promote rational use of energy by encouraging the use of low temperature heating systems and high temperature cooling systems of buildings. These systems that are suitable for office buildings, service buildings and residential buildings, can use a variety of fuels and renewable energy sources. These systems use energy efficiently while providing a comfortable indoor climate. They should be widely implemented now in order to create a possibility to use sustainable energy sources in the near future.

This publication is an official Annex report. The Summary Report summarises and presents the contents of the Guidebook, which is included here in CD-ROM format. The Guidebook is meant to help engineering offices, consultants and architects in their search for energy efficient heating and cooling systems that can provide the occupants with comfortable, clean and healthy environment. In addition, some background information is offered for real estate builders, building maintenance managers, political decision makers and the public at large. The Guidebook is also freely available on the internet (www.lowex.net).

Exergy defines the quality of energy and is an important tool for designing and assessing different heating and cooling systems. Application of exergy analysis into buildings has not been common before the implementation of Annex 37. Tools for exergy analysis of buildings were developed during the working time of Annex 37 and are presented in the Summary Report and included in the CD-ROM Guidebook. Exergy analysis can also be applied to human body to find optimal thermal conditions. Studies show that the lowest human body exergy consumption occurs at thermally neutral condition. The findings suggest that we may be able to establish both thermal comfort and low-exergy consuming systems at the same time. The human body exergy analyses have now just started to articulate why low exergy systems are essential for creating rational and comfortable built environment.

In Annex 37, 'low exergy (or LowEx) systems' are defined as heating or cooling systems that allow the use of low valued energy as the energy source. In practice, this means systems that provide heating or cooling energy at a temperature close to room temperature. There are currently many low exergy technologies available. Low temperature systems successfully combine both traditional and innovative new approaches to heating. Usually the heat is transferred into the room through air or liquid circulation systems and the same system can often be used for both heating and cooling.

Research shows that people living in houses with low temperature heating systems are very satisfied with ambient indoor air quality. In particular, thermal comfort levels are considered to be higher than in houses with a traditional heating system. Residents also experienced a reduction in draughts and dust, and reported fresher air in houses with low temperature heating systems. The advantages and disadvantages, mentioned by the occupants in the survey conducted during Annex 37, are similar to results in the literature. Also experiences from the case studies supported the findings from literature and the occupants' survey.

By using low temperature heating systems the room temperature can be decreased by a few degrees, which is more energy efficient and healthier for occupants. Low temperature

heating systems do not usually require radiators, which can be unsightly and hard to clean. This offers the additional advantages of increased living space and more flexibility in terms of interior design. Safety can also be improved during the heating season due to absence of hot radiator surfaces.

The demonstration projects of Annex 37 show the wide variety of possibilities to apply low exergy heating and cooling systems in buildings. There are examples of low exergy systems in dwellings and offices, but also in a museum and a concert hall.

The application of low exergy systems provides many additional benefits besides energy supply such as: improved thermal comfort, improved indoor air quality and reduced energy consumption. These aspects should be further promoted to increase the application of low exergy systems for heating and cooling of buildings. The building regulations and energy strategies should take the quality of energy into account more than today.

Wide application of low exergy heating and cooling systems in buildings will create a building stock, which will be able to adapt to use of sustainable energy sources, when desired. Without this ability, the transfer towards an energy-wise sustainable world will be delayed for decades.

PREFACE

INTERNATIONAL ENERGY AGENCY

The International Energy Agency (IEA) was established in 1974 within the framework of the Organisation for Economic Co-operation and Development (OECD) to implement an international energy programme. A basic aim of the IEA is to foster co-operation among the twenty-four IEA participating countries and to increase energy security through energy conservation, development of alternative energy sources and energy research, development and demonstration (RD&D).

ENERGY CONSERVATION IN BUILDINGS AND COMMUNITY SYSTEMS (ECBCS)

The IEA sponsors research and development in a number of areas related to energy. In one of these areas, energy conservation in buildings and community systems, the IEA is sponsoring various exercises to predict more accurately the energy use of buildings, including comparison of existing computer programmes, building monitoring, comparison of calculation methods, energy management systems as well as air quality, studies of occupancy and in depth evaluation of impact on energy consumption of the building enclosure.

THE EXECUTIVE COMMITTEE

Overall control of the programme is maintained by an Executive Committee, which not only monitors existing projects but also identifies new areas where collaborative effort may be beneficial. To date the following projects have been initiated by the Executive Committee on energy conservation in buildings and community systems (completed projects are identified by (*)):

Annex 1: Load Energy Determination of Buildings (*)	Annex 27: Evaluation and Demonstration of Domestic Ventilation Systems (*)
Annex 2: Ekistics and Advanced Community Energy Systems (*)	Annex 28: Low Energy Cooling Systems (*)
Annex 3: Energy Conservation in Residential Buildings (*)	Annex 29: Daylight in Buildings (*)
Annex 4: Glasgow Commercial Building Monitoring (*)	Annex 30: Bringing Simulation to Application (*)
Annex 5: Air Infiltration and Ventilation Centre	Annex 31: Energy related Environmental Impact of Buildings (*)
Annex 6: Energy Systems and Design of Communities (*)	Annex 32: Integral Building Envelope Performance Assessment (*)
Annex 7: Local Government Energy Planning (*)	Annex 33: Advanced Local Energy Planning (*)
Annex 8: Inhabitants Behaviour with Regard to Ventilation (*)	Annex 34: Computer-aided Evaluation of HVAC System Performance (*)
Annex 9: Minimum Ventilation Rates (*)	Annex 35: Design of Energy Efficient Hybrid Ventilation (HYBVENT)(*)
Annex 10: Building HVAC System Simulation (*)	Annex 36: Retrofitting of Educational Buildings – REDUCE (*)
Annex 11: Energy Auditing (*)	Annex 37: Low Exergy Systems for Heating and Cooling of Buildings
Annex 12: Windows and Fenestration (*)	Annex 38: Solar Sustainable Housing
Annex 13: Energy Management in Hospitals (*)	Annex 39: High Performance Insulation Systems
Annex 14: Condensation and Energy (*)	Annex 40: Building Commissioning to Improve Energy Performance
Annex 15: Energy Efficiency in Schools (*)	Annex 41: Whole Building Heat, Air and Moisture Response (MOIST-EN)
Annex 16: BEMS 1 - User Interfaces and System Integration (*)	Annex 42: The Simulation of Building-Integrated Fuel Cell and Other Cogeneration Systems (COGEN-SIM)
Annex 17: BEMS 2 – Evaluation and Emulation Techniques (*)	Annex 43: Testing and Validation of Building Energy Simulation Tools
Annex 18: Demand Controlled Ventilation Systems (*)	Annex 44: Integrating Environmentally Responsive Elements in Buildings
Annex 19: Low Slope Roof Systems (*)	
Annex 20: Air Flow Patterns within Buildings (*)	
Annex 21: Thermal Modelling (*)	
Annex 22: Energy Efficient Communities (*)	
Annex 23: Multi-zone Air Flow Modelling (COMIS) (*)	
Annex 24: Heat, Air and Moisture Transfer in Envelopes (*)	
Annex 25: Real time HVAC simulation (*)	
Annex 26: Energy Efficient Ventilation of Large Enclosures (*)	

ACKNOWLEDGEMENTS

The material presented in this publication has been collected and developed within an Annex of the IEA Implementing Agreement Energy Conservation in Buildings and Community Systems (IEA ECBCS), Annex 37 "Low Exergy Systems for Heating and Cooling of Buildings" (LowEx).

The Summary Report and the Guidebook are the result of a joint effort of many countries. All those who have contributed to the project by taking part in the writing process or the numerous discussions, are gratefully acknowledged. A list of the 11 participating countries with central contacts can be found in part A. In addition, Greece and Slovenia participated in form of a couple of case studies considering LowEx applications in existing (LowExx) buildings, collected in a special LowExx project. The contact information of the participants of the LowExx project can be found on the CD as well as an extended list of participating institutes and individuals of Annex 37. The participating countries have all contributed to the Guidebook by collecting information in their own countries. However, some of the Annex participants have taken the responsibility of collecting the information or writing the chapters in the Guidebook. They are

Mia Ala-Juusela, VTT, Finland (editor, Subtask D coordinator)
Claude Francois, CSTB, France (especially chapter 3)
Abdelaziz Hammache, NRCAN, Canada (especially chapter 2 and 3.2)
Koichi Isawa, Musashi Institute of Technology, Japan (chapter 2)
Gudni Jóhannesson, KTH, Sweden (especially chapter 4, Subtask B coordinator)
Alain Legault, NRCAN, Canada (Subtask A coordinator)
Åsa Nystedt, VTT, Finland (co-editor, Subtask D coordinator 2002)
Peter Op't Veld, CH, The Netherlands (especially chapter 5, Subtask C coordinator)
Paul Ramsak, Novem, the Netherlands (especially chapter 5.4.3)
Masaya Saito, Cornell University, USA (chapter 2)
Dietrich Schmidt, KTH, Sweden (important contribution to almost every chapter)
Masanori Shukuya, Musashi Institute of Technology, Japan (especially chapter 2)
Carey Simonson, University of Saskatchewan, Canada (Operating Agent 2001)
Markku Virtanen, VTT, Finland (Operating Agent 1999-2000 and 2002-2004)
Johann Zirngibl, CSTB, France (especially chapter 3)

On behalf of all participants, the members of the Executive Committee of IEA ECBCS as well as the funding bodies are also gratefully acknowledged.

Per Heiselberg, the editor of IEA ECBCS Annex 35 Final report is gratefully acknowledged for providing an outstanding example of how to compile an interesting-looking and yet comprehensive Guidebook.

CONTENTS

ABSTRACT	3
PREFACE	5
ACKNOWLEDGEMENTS	6
CONTENTS	7
1. INTRODUCTION	8
How to use the Guidebook	8
About the Annex 37	9
Energy, exergy and environment	11
Why exergy approach?	11
Historical overview on exergy concept	12
2. THE EXERGY APPROACH	13
Introduction to the concept	14
Difference between energy and exergy analysis	15
The human body consumes exergy for thermal comfort	16
3. ANALYSIS TOOLS FOR THE EXERGY CHAIN	19
Educational exergy analysis tool for heating	20
Pre-design tool for heating and cooling	22
4. CONCEPTS AND TECHNOLOGIES	24
Summary table of the LowEx technologies	24
LowEx system concepts	27
Strategies for design of low exergy systems in buildings	30
5. EXAMPLES OF LOWEX BUILDINGS	31
Summary table of case studies	31
Retrofits	33
Advantages and limitations of low exergy systems	34
6. MARKET POSSIBILITIES	38
7. STRATEGIES AND POLICIES	40
8. CONCLUSIONS	41
9. REFERENCES	43
A. PARTICIPATING COUNTRIES	
B. COMPANY AND PRODUCT INFORMATION	
C. ADDITIONAL INFORMATION	
D. PUBLISHED ARTICLES	

1. INTRODUCTION

This publication is a Summary Report presenting and summarising the contents of the LowEx Guidebook (referred to as Guidebook in this publication), which is attached to this Summary Report as a CD-ROM.

The Guidebook is the achievement of the work done in the IEA ECBCS Annex37 “Low exergy systems for heating and cooling of buildings”. The Guidebook is available as a CD-ROM version and also freely available on the internet (<http://www.lowex.net>). Since many readers prefer to just print out the whole thing at once, you can choose to open the Guidebook as a pdf-version and print it out. The CD-ROM version, however, offers a more user friendly environment and some additional information.

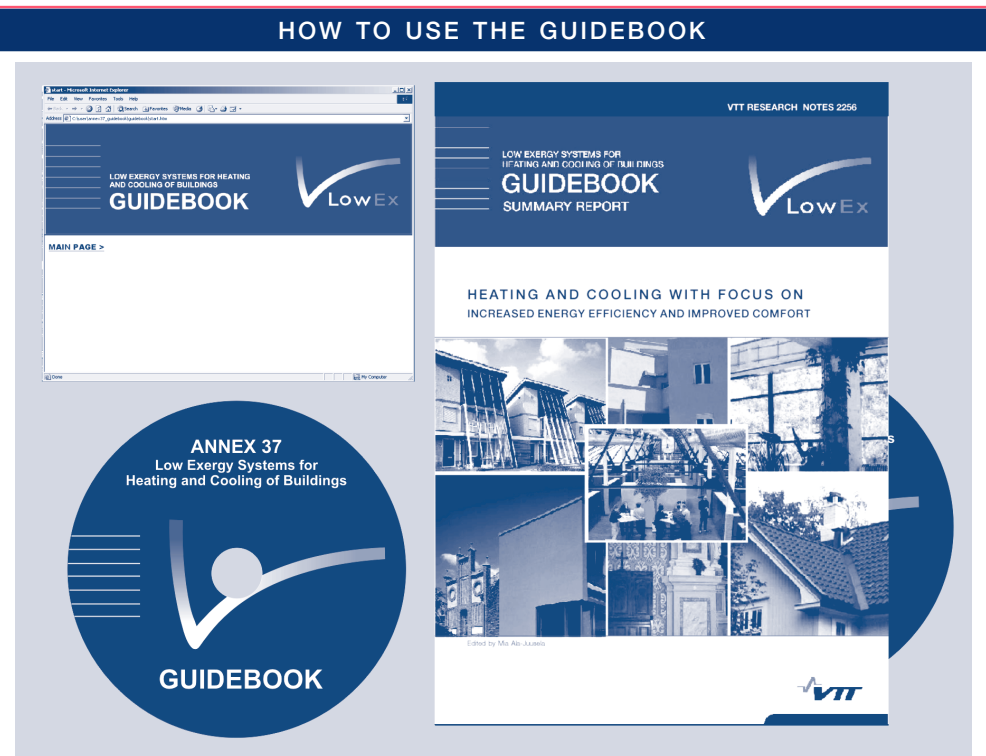

Figure 1. The final results of Annex 37 are presented in many formats.

The Guidebook is intended to be useful for architects and engineers designing heating and cooling systems of buildings. A database of low exergy components is completed with the guidelines for selection of products (in Chapter 4). Examples of system concepts for different buildings and climates are presented (in Chapter 5) as well as a set of tools for analysis (described in Chapter 3, included in the CD-ROM). All this is expected to be helpful for engineering offices, consultants and architects in their search for energy efficient heating and cooling systems that can provide the occupants with comfortable, clean and healthy environment.

An analysis of case studies (in Chapter 5) together with rationale of exergy concept (in Chapter 2) and recommendations concerning regulations in building sector and energy tariffs (in Chapter 7) are expected to be helpful for real estate builders, building maintenance managers, political decision makers and the public at large. The description of the current market situation (in Chapter 6) offers the reader additional background information about the situation in different countries.

The CD-ROM version of the Guidebook includes the same information as the printable version, but it offers the user some additional opportunities in moving around in the Guidebook. Through the “Annex 37 Countries” page the user has access to the country specific information, like the national contact persons and case examples as well as the climate and housing standards. The country specific pages also include information about the companies that provide services in the LowEx field and are located in the country in question. There is a link to the country’s Market Analysis and Strategies and Policies chapters. From the summary tables of the LowEx technologies and the case examples, the user can choose projects or technologies matching certain criteria. There is a link from the technologies table to the case examples, where these technologies have been used and vice versa. We have also collected some Additional Information to the CD-ROM. This includes the Technical reports written for the ECBCS ExCo, the LowEx Newsletters, an English Brochure, the publication called “Introduction to Exergy”, published articles etc.

ABOUT THE ANNEX 37

LowEx, the international low temperature heating systems research programme (IEA ECBCS Annex 37), is part of the International Energy Agency's (IEA) Energy Conservation in Buildings and Community Systems programme (ECBCS). The aim of the programme was to promote rational use of energy by encouraging the use of low temperature heating systems and high temperature cooling systems of buildings. In Annex 37 these systems are called low exergy (or LowEx) systems.

BACKGROUND

“Energy saving” and emission reduction are both affected by the energy efficiency of the built environment and the quality of the energy carrier in relation to the required quality of the energy. Taking into account qualitative aspects of energy leads to introduction of the exergy concept in comparison of systems, which is the key idea of Annex 37. Exergy is energy, which is entirely convertible into other types of energy. High valued energy such as electricity and mechanical workload consists of pure exergy. Energy, which has a very limited convertibility potential, such as heat close to room air temperature, is low valued energy. Low exergy heating and cooling systems allow the use of low valued energy, which is delivered by sustainable energy sources (e.g. by using heat pumps, solar collectors, either separate or linked to waste heat, energy storage etc.). Common energy carriers like fossil fuels deliver high valued energy. The reason for “energy saving” being in quotation marks in the first sentence, is that we actually are talking about saving exergy, not energy!

Future buildings should be planned to use or to be suited to use sustainable energy sources for heating and cooling. One characteristic of these energy sources is that only a relatively moderate temperature level can be reached, if reasonably efficient systems are desired. The development of low temperature heating and high temperature cooling systems is a necessary prerequisite for the usage of alternative energy sources. The basis for the needed energy supply is to provide occupants with a comfortable, clean and healthy environment.

LOWEX SYSTEMS

In Annex 37, 'low exergy (or LowEx) systems' are defined as heating or cooling systems that allow the use of low valued energy as the energy source. In practice, this means systems that provide heating or cooling energy at a temperature close to room temperature.

Figure 2. The transition from high valued energy sources to low valued energy sources requires appropriate heating and cooling systems in buildings. Heating and cooling systems that provide heating or cooling energy at a temperature close to room temperature (i.e., low exergy or LowEx systems) are a prerequisite for the efficient utilisation of low valued energy sources. On the other hand, the efficiency of high valued energy sources is less dependent on the heating and cooling systems in buildings.

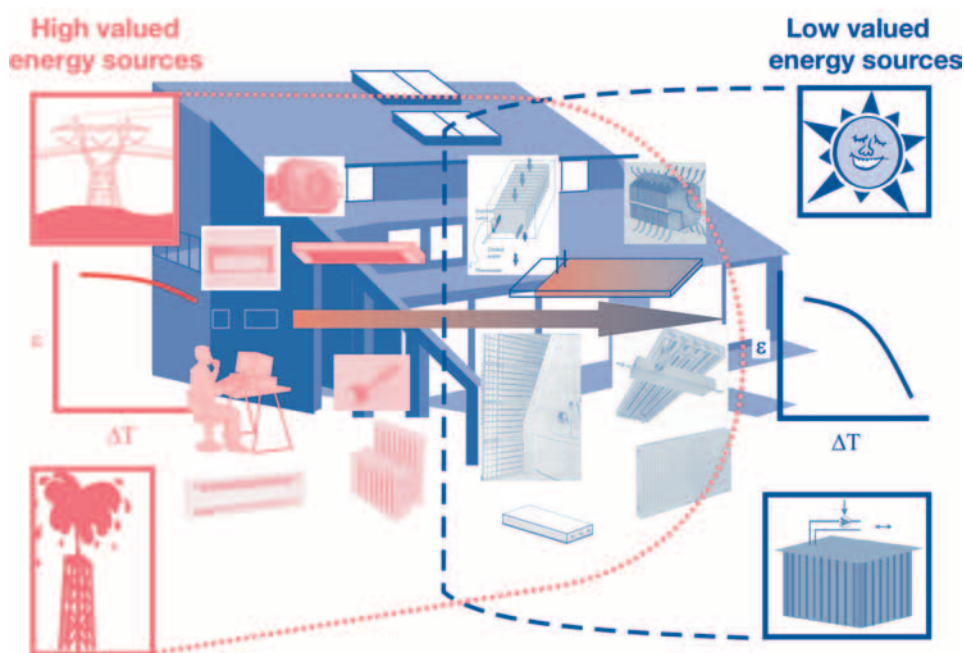

OBJECTIVE AND SCOPE

The general objective of the Annex 37 was to promote rational use of energy by means of facilitating and accelerating the use of low valued and environmentally sustainable energy sources for heating and cooling of buildings.

The interest of the Annex 37 covers all types of buildings. Both new and retrofitted buildings are considered. Attention is paid to the impact of the building on the whole energy chain. The building is regarded as a system. Life cycle aspect and environmental impacts of systems are discussed. End users point of view and behaviour are taken into account.

STRATEGY

Four subtasks were carried out in order to reach the objectives:

- Subtask A: Exergy Analysis Tools for the Built Environment
Tools were developed to enable an assessment of low exergy technologies, components and systems.

- Subtask B: Low Exergy Concepts and Technologies

A database of low exergy components was created, and the advantages, requirements and limitations of the components were assessed.

- Subtask C: Case Studies and Market Potentials

Practical experiences gained from the installed low exergy systems were collected and the market possibilities of low exergy systems in different countries were analysed.

- Subtask D: Documentation and Dissemination

The Annex research results were compiled and disseminated. Means of influencing the energy policies and regulations in order to promote the use of low exergy systems were looked for.

Figure 3a and b. The scope of Annex 37 covers both environmental impacts of the systems and the end user's point of view. Both new and retrofitted buildings are considered.



ENERGY, EXERGY AND ENVIRONMENT

The necessity for an increase in the efficiency of energy utilisation in buildings is obvious and indisputable. Heating, cooling and lighting appliances in buildings cause more than one third of the world's primary energy demand (ECBCS 2002). Thus, the building stock contributes as a major actor to the energy related environmental problems.

The growing concern of environmental problems, such as global warming, which have been linked to the extended use of energy, has increased both the importance of all kinds of so called "energy saving measures", and the necessity for an increased efficiency in all forms of energy utilisation. Despite the efforts made to improve energy efficiency in buildings, the issue of gaining an overall assessment, and comparing different energy sources still exists. Today's analysis and optimisation methods do not distinguish between different qualities of energy flows during the analysis. An assessment of energy flows from different sources is first done at the end of the analysis by weighting them with the primary energy factors. The primary energy factors necessary for the calculation are not based on analytical ground or thermodynamic process analyses, yet they have been derived from statistical material and political discussion (DIN 4701-10 2001).

In the theory of thermodynamics, the concept of exergy is stated to be the maximum work that can be obtained from an energy flow or a change of a system. The exergy content expresses the quality of an

energy source or flow. This concept can be used to combine and compare all flows of energy according to their quantity and quality. Exergy analysis is commonly used in, for example, the optimisation processes of power stations. This method can be applied to buildings, as well. Most of the energy is used to maintain room temperatures at around 20 °C. In this sense, because of the low temperature level, the exergy demand for applications in room conditioning is naturally low. In most cases, however, this demand is satisfied with high quality sources, such as fossil fuels or using electricity. Exergy analysis provides us with additional information on where and when the losses occur. It helps us to see in which part of the energy chain the biggest savings can be achieved. (Schmidt 2004)

The need for energy saving is based on the will to reduce the effects of our actions to the environment. The negative environmental effects of energy production are mainly due to the use of fossil fuels. When all energy will be produced with renewable energy sources, then it becomes less interesting to save exergy. This is why we also want to include solar energy to our sources, even if it is a high exergy source.

WHY EXERGY APPROACH?

According to the first law of thermodynamics, energy can't be conserved or used, it can only change forms. Thinking about this first law, makes you wonder how we can be talking about "saving energy" or "energy consumption" if it can't be saved or consumed!

What we really should start talking about, because this is what we actually mean, is "saving exergy" and "exergy consumption". This is more explained in chapter 2. The more you learn about exergy, the more absurd it feels like to talk about energy - when we actually mean exergy.

Why couldn't we use the primary energy approach? If we always took into account the primary energy needed to perform something, we would get far better results in our energy-analyses; with that perspective it would be clear that 1 kWh doesn't always mean the same thing as another 1 kWh. One reason for using the exergy approach and not just settling for the primary energy approach is that it is physically more correct to talk about exergy- than energy consumption and production.

It is a fact that the term "exergy" is an unknown term even for scientists not to mention "people on the street". In order to make this term less "strange" we need to first of all start talking more about it and stop using the term energy when we actually mean exergy. The publication "Introduction to the Concept of Exergy- for a Better Understanding of Low Temperature Heating and High Temperature Cooling Systems" that has been published by members of the Annex 37 group, gives the term exergy a clear explanation. By disseminating this publication widely we contribute to making the term more known. Most of the contents of this publication can be found in chapter 2 of the Guidebook.

HISTORICAL OVERVIEW ON EXERGY CONCEPT

The method of exergy analyses, based on the second law of thermodynamics and the irreversible production of entropy, is neither new nor modern. The early fundamentals were already stated by Carnot in 1824 and Clausius in 1865 (Ahern 1980).

Figure 4a and b. The parish church St Tilen in Mokronog, Slovenia was built in 1824, the same year Carnot first stated the fundamentals for exergy. In its renovation in 1999, a low exergy heating system was installed. Project was led and monitoring of wall tempering system was realised by Building and Civil Engineering Institute ZRMK (Malovrh and Praznik 2002).



Even though modern textbooks on thermodynamics (Moran and Shapiro 1998) and lecture notes for university students include chapters on the second law of thermodynamics and the concept of entropy and exergy, the practical use of these concepts has been very limited. Energy related systems are designed and their performance is evaluated mainly by using the energy balance of the first law of thermodynamics alone. An example of this is the newly established German energy conservation regulation EnEV, in which the overall system performance and the assessment of energy flows from different sources are evaluated from the calculated amount of the primary energy use (Maas et al. 2002).

Although exergy analysis is not being widely used, there is a growing concern about the second law of thermodynamics in reports and books, which promote the use of this named method. Yet, due to difficulties and the complexity of these concepts, there still seems to be a lack of acceptance amongst engineers (Ahern 1980). Intensive literature studies have been carried out, showing the advantages of the proposed method (Cornelissen 1997, Wall 1986 and Ahern 1980).

The method of exergy analyses has been primarily developed in Europe, especially in Germany, Poland and the former Soviet Union. The term "exergy", first used by

Rant in 1956, has been connected to the capability to do work or the available work from a process, and the Carnot efficiency of thermal systems. Baehr used the method for the analyses of power stations in 1965 and provided several examples of exergy calculations. He presented analytical results by comparing flowcharts of exergy analyses with energy calculations based on the first law of thermodynamics. The results clearly show the significant differences obtained by these two methods of analysis (Ahern 1980).

The discussed references are just a small portion of the literature to be found on the second law of thermodynamics and although engineers and physicists have been studying this subject since Carnot's days, it is still under controversial and ambitious discussion (Ahern 1980). The texts available (Wall 1986, Cornelissen 1997) indicate the strong belief of the authors that exergy analysis and the application of the second law of thermodynamics are important aspects in designing and evaluating all energy systems. As the concern about questions and problems regarding the efficient use of energy is growing, pioneering efforts made in the past should be extended and implemented to commonly used methods for engineering system design and performance analysis. The simplicity of the exergy analysis method might help in reaching this goal (Ahern 1980).

In case of building applications, only a few papers, mainly from Japanese (Shukuya 1994, Asada and Shukuya 1999, Nishikawa and Shukuya 1999) and German (Baehr 1980, Gertis 1995, Steimle 2000, Klemp 1997, Jenni and Hawkins 2002) research teams, have been published. Annex 37 working group continued the development of the use of exergy concept in connection with buildings and making the exergy concept more understandable and familiar to the public.

From an article by Schmidt (2004).



2. THE EXERGY APPROACH

Chapter 2 in the Guidebook describes the general characteristics of a thermodynamic concept, exergy, which enables us to articulate what is consumed by all working systems, whether they are man-made systems, such as thermo-chemical engines, or biological systems including the human body. The chapter focuses especially on its application to describing building heating and cooling systems. An example is given about the possibilities of exergy analysis to find the boundary conditions for thermal comfort of the human body. In this Summary Report, the basic concept is described, followed by an example, which helps to understand the difference between energy and exergy analyses. Summary of the human body exergy analysis example is also given.



Figure 5a and 5b. All working systems, biological or manmade, consume exergy.

Today calculations of energy use in buildings are based solely on the energy conservation principle, the first law of thermodynamics. As shown in chapter 2 of the Guidebook, through analyses and examples, the energy conservation concept alone is not adequate enough to gain a full understanding of all the important aspects of energy utilisation processes. From this point of view, the method of exergy analyses based on a combination of the first and second law of thermodynamics is presented, as the missing link needed to fill the gap in understanding and designing energy flows in buildings.

The basic principles for exergy analysis have already been stated in the nineteenth century, but the term exergy was first introduced in the mid-1950s. The difference between energy and exergy analysis is explained with examples in chapter 2.3 of the Guidebook.

By typical cases of heating and cooling, the advantages of exergy analysis are shown. The calculation examples in chapters 2.9- 2.10 of the Guidebook suggest that to achieve an exergy optimised building design, loads on the

building service system have to be reduced as much as possible. First after that, in a good building shell, further improvements on the building service system seem to be meaningful. Therefore, rational passive design seems to be a prerequisite of realising low exergy systems for heating and cooling of buildings.

The human body exergy analyses have now just started to articulate why low exergy systems are essential for creating rational and comfortable built environment. Examples of human body exergy analysis are presented in chapter 2.11 of the Guidebook.

INTRODUCTION TO THE CONCEPT

People often claim that energy is consumed; this is not only in everyday conversation but also even in scientific discussion associated with so-called energy and environmental issues. This claim, however, conflicts with the first law of thermodynamics stating that the total amount of energy is conserved even though forms of energy may change from one to another.

When we use such expressions as “energy consumption”, “energy saving”, and even “energy conservation”, we implicitly refer to “energy” as intense energy available from fossil fuels or from condensed uranium. But, it is confusing to use one of the most well-established scientific terms, energy, to mean “to be conserved” and “to be consumed” simultaneously. This is why we need to use the thermodynamic concept, exergy, to articulate what is consumed.

ACTIVE AND PASSIVE SYSTEMS

Over the last two decades various so-called “energy saving” measures have been conceived, developed, and implemented in building envelope systems and also their associated environmental control systems such as lighting, heating, and cooling systems. Those measures can be categorised into two groups: those for “passive” systems and those for “active” systems (Figure 6).

“Passive” systems are defined as building envelope systems to make use of various potentials to be found in the immediate environment such as the sun, wind, and others to illuminate, heat, ventilate, and cool the built environment.

“Active” systems are the systems

consisting of various mechanical and electric components such as fans, pumps, heat pumps, and others, all of which work by the use of fossil fuels. Most of the active systems available these days have been developed with an assumption of the abundant use of fossil fuels so that they do not necessarily work in harmony with passive systems.

LOW EXERGY SYSTEMS

Low temperature heating systems are such kind of “active” heating systems that should fit the built environment to be conditioned primarily by “passive” heating systems. A good thermal-environmental condition within built spaces in the winter season can be provided basically with the installation of thermally-well-insulated building materials with appropriate heat capacity, which make it possible to utilise heat sources of lower temperature for heating.

In summer season, a moderate thermal-environmental condition within built spaces may be provided with a combination of nocturnal ventilation, the installation of appropriate shading devices for glass windows, and the reduction of internal heat gain in addition to the use of thermally-well insulating materials with appropriate heat capacity for building envelopes. This would allow the utilisation of cold sources with higher temperature for cooling.

The use of the exergy concept in describing various heating and cooling systems, whether they are passive or active, would enable us to have a better picture of what low temperature heating and high temperature cooling systems are.

From Shukuya and Hammache (2002)



Figure 6. The LowEx case building “IDIC” in Iwate, Japan has both active and passive systems for environmental control, (see case JPN 5 in the Guidebook).

DIFFERENCE BETWEEN ENERGY AND EXERGY ANALYSIS

Simple examples can help to enhance the understanding of the differences in energy and exergy analyses.

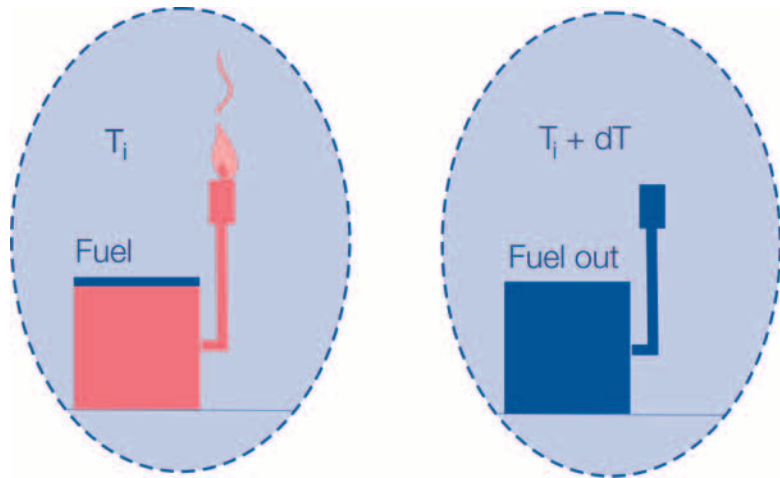

Figure 7. Combustion of fuel in air as an example to show the difference between energy and exergy analysis (Moran 1989, modified).

A large enclosure with adiabatic boundaries containing a lot of air at the initial temperature of T_i and a small container of fuel are shown in Figure 7. It is furthermore supposed that the fuel burns in air, heating the surrounding air and environment so that there is a slightly warm mixture of combustion products and air in the final state. It is obvious that the total quantity of energy in the enclosure is the same as in the initial

state. But the combination of fuel and air in the initial state has a greater potential to be useful than the warm mixture in the final state. The fuel can be used in a device to generate electricity, do work or heat rooms. But the uses for the slightly warm combustion products are much more limited. It can be stated that the initial potential has been destroyed to a large extent (Moran and Shapiro 1998).

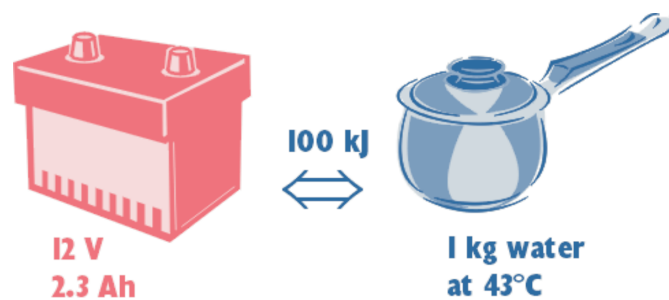

Figure 8. Both systems contain the same amount of energy but not the same amount of exergy.

The same fact, that there is an energy quality, can be illustrated by another example evident for us from our experience in daily life (Figure 8).

It is obvious that 100 kJ electricity stored in a 12 V / 2.3 Ah car-battery is more useful, easier to transform into something useful for us, than the same amount of energy stored in 1 kg water at a temperature of 43 °C in an ambient temperature of 20 °C. The electricity is suitable for running

a machine, like a computer, operating a light bulb of 40 W for 42 min or at least heating 1 kg of water with 23 °C. The 100 kJ heat contained in the 1 kg water is only suitable for washing our hands or doing the dishes. It becomes clear that there is a difference between the types of energy. By introducing the term exergy we appreciate the fact that energy manifests itself by its quantity and its quality (Schmidt 2001).

As explained in chapter 2.2. of the Guidebook, the exergy-entropy process of any working system consists of the following four fundamental steps: The systems first feed on exergy and then consume a portion of it or all of it to perform their purposes while at the same time producing entropy as the result of exergy consumption, and finally they discard the produced entropy into the environment. The human body, which occupies the built environment controlled by heating and cooling systems, is no exception.

THE HUMAN BODY CONSUMES EXERGY FOR THERMAL COMFORT

We humans feed on exergy contained by food, and thereby consume it within our body so that we can sense, think and perform any physical work by contracting our muscles. In due course, we inevitably produce entropy, and it must be discarded into the built environment as symbolically shown in Figure 9.

Heating and cooling systems in buildings, whether they are active or passive, also work as exergy-entropy processes. This is what thermodynamics tells us. “Exergy” is the concept to articulate what is consumed within a system, and “entropy” is what is disposed of as waste from the system. In other words, exergy is the concept that quantifies the ability of energy and matter to disperse, and entropy is the concept that quantifies how much energy and matter are dispersed.

EXERGY BALANCE OF THE HUMAN BODY

It is vitally important to have a clear image of the exergy balance of the human body in order to understand what the low exergy systems for heating and cooling in buildings are. Therefore a mathematical model of the human body exergy balance was developed and its numerical calculation

was made and the result was related to human thermal sensation (Saito and Shukuya 2000).

EXAMPLE OF HUMAN BODY EXERGY CONSUMPTION

Figure 10 shows one of the results of the numerical calculation assuming a thermally steady-state environmental condition (Saito and Shukuya, 2000; Saito et al 2002). This is the relationship between the warm and wet exergy-supply rate (input), the exergy consumption rate, the rate of exergy storage, the rate of exergy output from human body and the environmental temperature with the corresponding thermal sensation (PMV*).

Exergy consumption within the human body becomes higher in a cold environment due to larger difference in temperature between the human body and its surrounding space and also becomes higher in a hot environment mainly due to sweating.

It is interesting that the thermally comfortable condition is provided with the lowest exergy consumption rate within the human body. This suggests that rational heating and cooling systems in buildings would work well with low exergy consumption

The general form of exergy balance equation of a system is described as follows.

$$\text{Input Exergy} - \text{Exergy Consumed} = \text{Stored Exergy} + \text{Output Exergy}$$



Figure 9. The human body works as an exergy-entropy process.

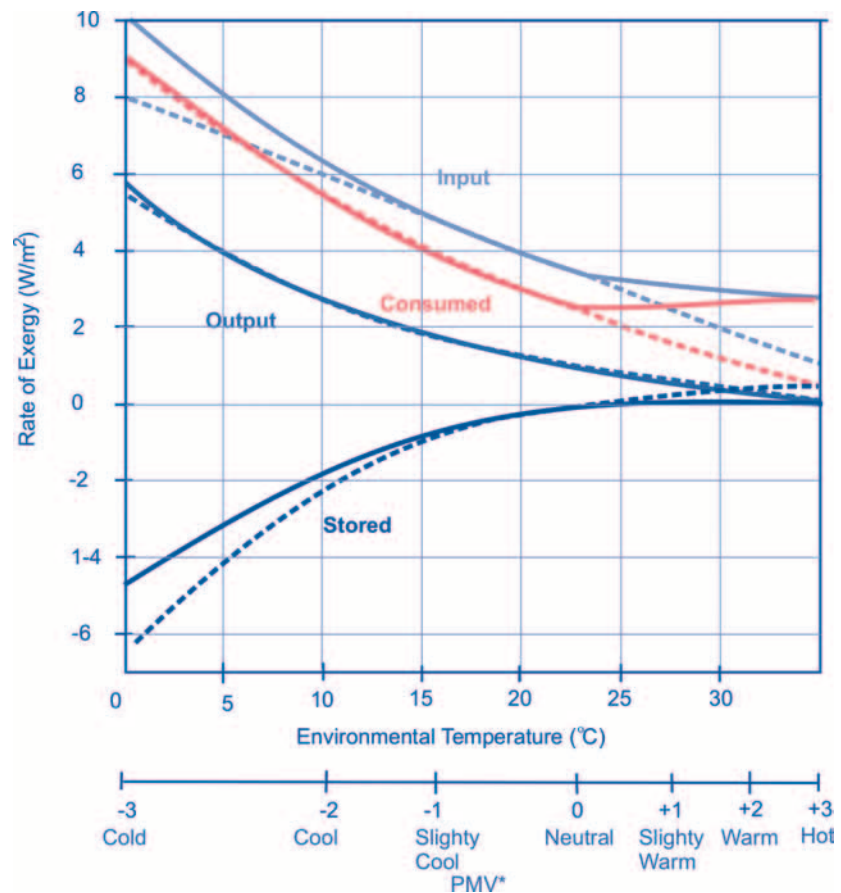

Figure 10. The relationship between the rates of exergy input, exergy consumed, exergy stored within the human body and also exergy output from the human body and the environmental temperature. The dotted lines represent a case of no shivering in cold condition or no sweating in hot conditions (Saito et al. 2002).

under a condition in which we humans consume as low amount of exergy as possible.

That is, we may be able to establish both thermal comfort and low-exergy consuming systems at the same time.

LOW EXERGY SYSTEMS AND HUMAN BODY EXERGY CONSUMPTION

As explained in the previous section, the lowest human body exergy consumption occurs at thermally neutral condition.

Further research on human body exergy balance has just come onto a new stage where it becomes possible to calculate more realistic cases than before, in which the environmental temperature for exergy calculation need not be presumed to be equal to the average indoor air temperature and mean radiant temperature. What

follows is a new finding which enhances the previous findings.

Figure 11 shows a new relationship between the human body exergy consumption, thermal comfort ($PMV^*=0$), room air temperature and mean radiant temperature.

The lowest exergy consumption rate emerges at the point where the room air temperature equals 18 °C and mean radiant temperature 25 °C. This suggests that the use of radiant warm exergy is more effective than the use of convective warm exergy for a heating purpose to realise both thermal comfort and as low exergy consumption within the human body as possible. Such a built environment can be provided by a moderate radiant heating system combined with passive heating strategies, for example, good thermal

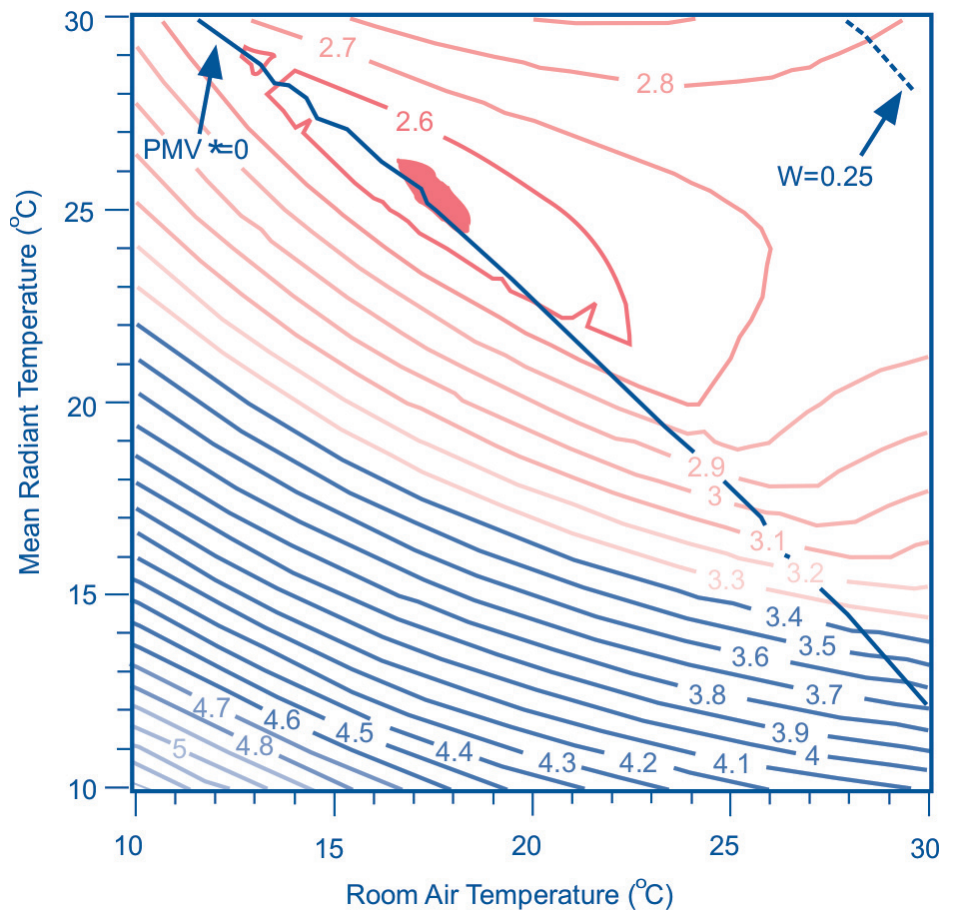

Figure 11. The relationship between exergy consumption within the human body (W/m^2), room air temperature, and mean radiant temperature. The solid line descending from the upper left corner to the lower right corner indicates thermally neutral conditions ($PMV^*=0$); this is based on 'energy' balance calculation. The broken line in the upper right corner is skin wetness up to the amount which most people find tolerable ($W=0.25$). There is an optimal combination of room air and mean radiant temperatures which results in the lowest exergy consumption and thermal comfort (Isawa et al. 2002).

insulation and suitable thermal exergy storage capacity of building envelopes, solar thermal exergy gain through properly insulated window glazing and others.

It is interesting to see that, from the exergetic point of view, there is an optimal combination of room air temperature and mean radiant temperature which results in thermally neutral conditions, namely $PMV^*=0$, although, from the conventional energetic point of view, there are many combinations of room air temperature and mean radiant temperature. Some experienced scientists and engineers say that what they can see in Figure 11 is consistent with their experiences. It would be very encouraging for architects and engineers to conceive a system with as low-exergy

consumption as possible since it would bring about a higher quality of warmth that the occupants can sense in their given built environment.

3. ANALYSIS TOOLS FOR THE EXERGY CHAIN

To increase the understanding of exergy flows in buildings and to be able to find possibilities for further improvements in energy utilisation in buildings, two pre-design analysis tools have been produced during ongoing work for the IEA ECBCS Annex 37.

Figure 12. Energy (or exergy) flows over the systems boundaries of a building (Schmidt 2004).

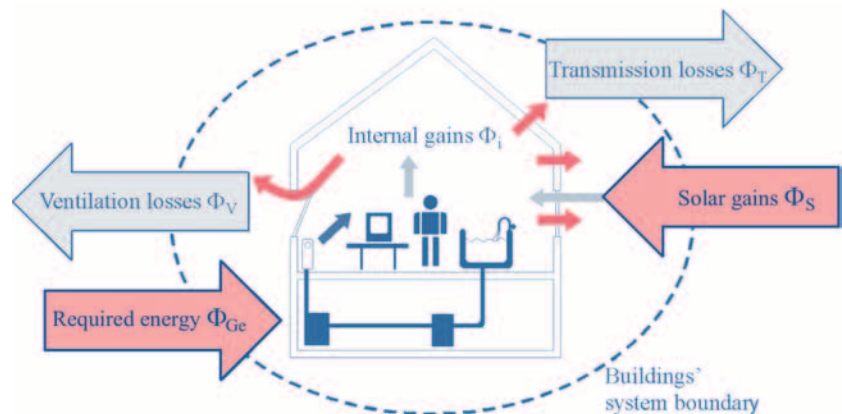

In the preparation phase of Annex 37, the working group set as an objective to collect the tools available on the market and to review them from the viewpoint of adaptability for exergy analyses. Quite quickly the group realised, that there were no representative off-the-shelf tools for exergy analysis of buildings. Because it was not possible to develop a very advanced tool in the frame of the Annex 37, the participants finally decided to develop guidelines for tool developers, instead of choosing one tool to be developed for exergy analysis. The guidelines include models for exergy analysis of different systems. They are presented in the publication "Introduction to the Concept of Exergy" by Shukuya and Hammache (2002).

Figure 13. Energy utilisation in building services equipment (according DIN 4701-10 2001, modified).

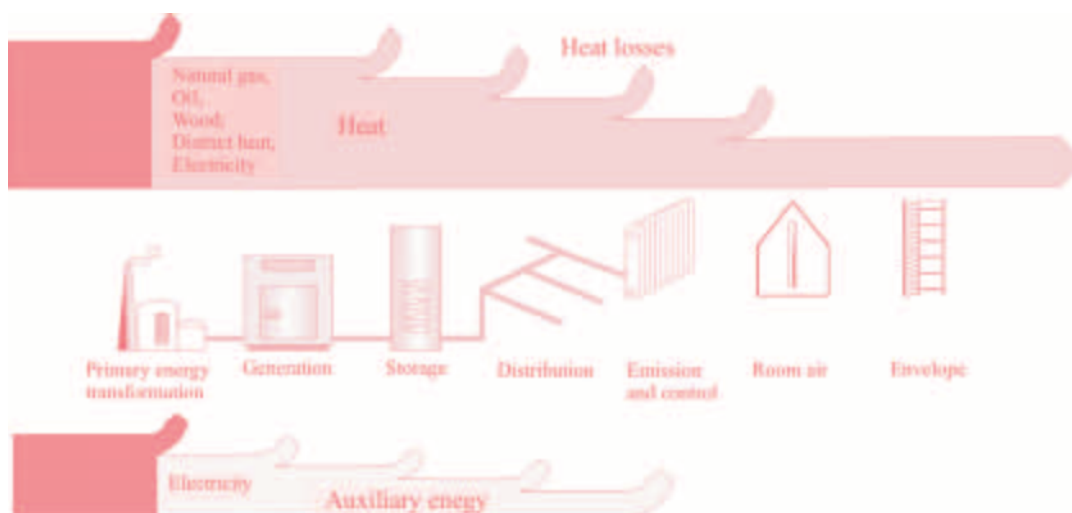

be advantageous in some energy chains compared to high exergy systems. This tool should be easy to use and show the exergy flow through a system or energy chain. Finally, two pre-design tools were developed (named as "the Pre-design tool" and "the Educational tool"). They are briefly described in this chapter, and more detailed descriptions can be found in the User-Guides of these tools (François et al. 2004a and b). Both the User-Guides and the tools are included in the CD-version of the Guidebook.

Both tools give outputs of similar format. The main difference is that the Pre-design tool is even more easy-to-use than the Educational tool, but it is therefore also less flexible. The ease-of-use is based on the drop-down lists, which are used more frequently in the Pre-design tool. In the Educational tool, the user has more options for the input parameters, but here the user

	<p>has to know more facts about the building and its systems. The Educational tool does an analysis of a single moment, as the Pre-design tool gives an estimate of the annual energy and exergy demand of the building.</p> <p>The exergy chain is described in chapter 2.1.1 of the Guidebook. An important step in the entire analysis is the estimation of the energy demand of the actual building. The heat demand is a key figure in the analysis, it corresponds to the building's exergy load. A low exergy load means a thermally good constructed building envelope. The energy requirement for the service equipment is then estimated. (Schmidt 2004)</p> <p>The main focus in the Guidebook is on the system "building", whose system border to be analysed here encompass the building envelope. All energy (or exergy) flows over the border are indicated in Figure 12. For the balance of energy flows</p>	<p>through the building, all possible effects have to be taken into account, even the extraction and production of the energy carrier. The calculation of energy flows caused by a building starts much earlier. (Schmidt 2004)</p> <p>For a deeper analysis of the energy flows in a building, a closer focus on the building services system is needed. The entire flow from the source to the sink, as indicated in Figure 13, must be taken into consideration. All energy flows from the left hand side, i.e. from the source, via a number of HVAC-components and the building structure itself, to the ultimate sink, the outdoor environment. Imperfections and losses in the different steps through the building are regarded, as well as the need for auxiliary energy. Energy, mainly in form of electricity, is needed to drive additional pumps and fans for the operation of the system. (Schmidt 2004)</p>
--	--	--

EDUCATIONAL EXERGY ANALYSIS TOOL FOR HEATING

<p>Throughout the development of the "Educational Tool for Energy and Exergy Analyses of Heating and Cooling Applications in Buildings", the aim was to produce a "transparent" tool, easy to understand for the target group of architects and building designers, as a whole. Other requirements were that the exergy analysis approach is to be made clear and the required inputs need to be limited. Today, the Microsoft Excel spreadsheet based tool has two input pages and results are summarised on two additional pages, with diagrams.</p>	<p>DESCRIPTION OF THE TOOL</p> <p>The detailed presentation of the tool can be found in the document called "User-Guide for the Educational Tool for Energy and Exergy analyses of Heating and Cooling Applications in Buildings" (François et al. 2004a).</p> <p>All steps of the energy chain - from the primary energy source, via the building, to the sink (i.e. the ambient environment) - are included in the analysis (Figure 14). The entire tool is built up in different blocks of sub-systems for all important steps in the energy chain. All components, building construction parts, and building services equipment, have sophisticated input possibilities. Heat losses in the different components are regarded, as well as the auxiliary electricity required for pumps and fans. The electricity demand for artificial lighting and for driving fans in the ventilation system is also included. On the primary energy side, the inputs are differentiated between fossil and renewable sources. The steady state calculation for this heating case is done in the direction of the development of demand.</p>	<p>Although the analysis follows the same main principles as European Standards do, the tool is aimed at calculations under steady state design condition, not at annual energy use calculations (the user can enter mean values of climatic data to represent seasonal or annual average conditions).</p> <p>The tool mainly presents seven parts of an excel worksheet. The worksheet is divided into seven different sections for the input and calculation of values.</p> <p>The user can run this tool for example to study:</p> <ul style="list-style-type: none"> - the impact of improvements in the building envelope versus improvements in the service equipment, - the system flexibility and the possible integration of renewable energy sources into building systems, - integration of heat pumps into the building design, - integration of balanced ventilation systems.
--	---	--

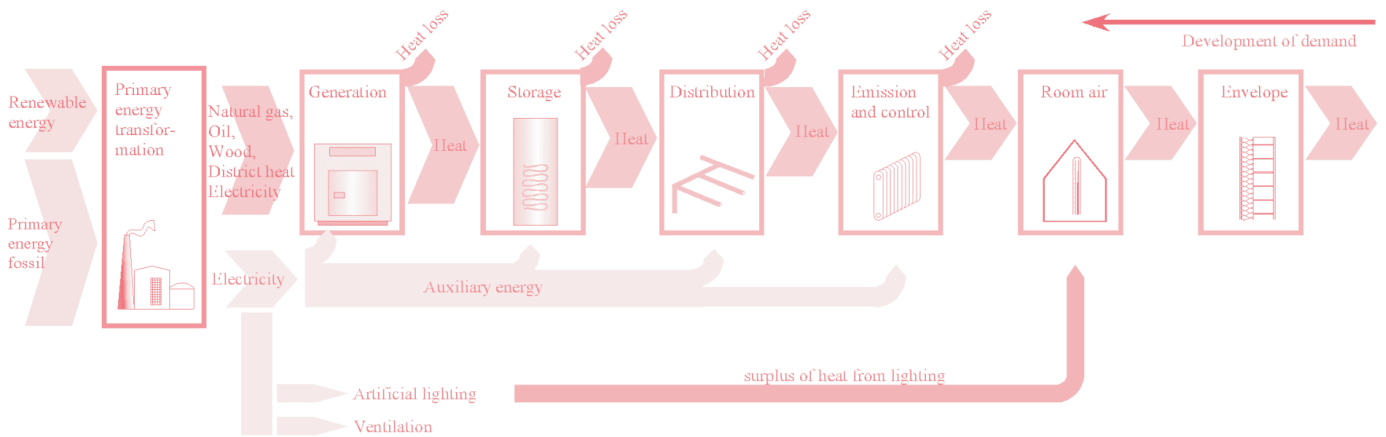

FORM OF RESULTS

The results are displayed as diagrams showing demands and losses by components (Figure 15). In these diagrams, it is easier to understand where inefficiencies occur and possible steps for a further increase in the system efficiency may be indicated.

Figure 14. Energy utilisation in building services equipment, the modelling method for the pre-design tool. The energy flows are shown from source to sink, in accordance to DIN 4701-10, modified.

Figure 15. The results of the tools are presented graphically.

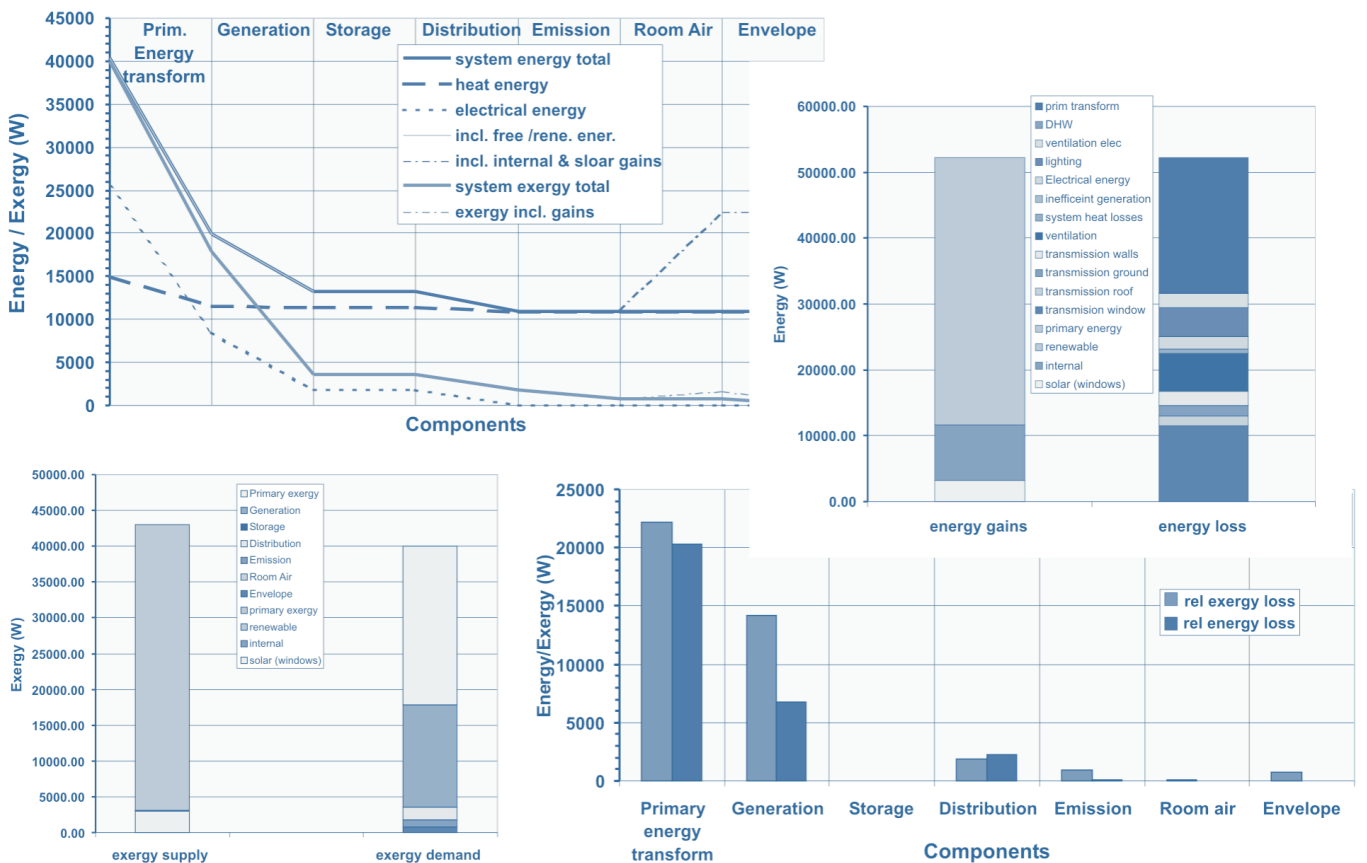

PRE-DESIGN TOOL FOR HEATING AND COOLING

The objective of the "Pre-Design Tool for Energy and Exergy Analyses of Heating and Cooling Applications in Buildings" is to provide designers or users with a simple tool that shows a holistic image of the energetic-flow and exergetic-flow patterns of various low temperature heating and high temperature cooling systems in buildings. For this purpose, the tool includes a program that estimates the heating and cooling requirements of a building using the well-known modified-bin method (ASHRAE 1997).

DESCRIPTION OF THE TOOL

The heating and cooling requirements are estimated using descriptive data where the user should enter the physical characteristics of the building and the characteristics of the site. Simplified energy and exergy analyses are carried out on the system components of selected heating and cooling technologies. The exergy analysis is carried out using estimated quality factors of the energy flow in the system.

It is important to emphasise that the tool is not intended to carry out sophisticated energy and exergy analyses that require more detailed information on the technologies, the subsystem configurations, the operating parameters and the energy vectors used, so that all the exergy components could be taken into account and calculated precisely. This will require more sophisticated software, which is beyond the objective set to the tool.

THE TOOL MAINLY PRESENTS SIX EXCEL WORKSHEETS:

1. Overview worksheet
2. Procedure worksheet
3. Input Parameters worksheet
4. Heating and Cooling Load worksheet
5. Heating worksheet
6. Cooling worksheet

More information on the contents of these worksheets and on the use of the tool can be found in the User-Guide of the tool (François et al. 2004b). It is included in the CD-ROM version of the Guidebook. Here, only some characteristics are given.

In order to provide a simple and easy-to-use tool, the inputs are mainly entered from drop-down lists on the Input Parameters worksheet. All the required input parameters for the computations are introduced

and explained. Typical values are provided for each parameter and since the methodology uses qualitative estimates on some parameters, the assumed values are also indicated in different tables.

For example, the heating and cooling applications are selected from drop-down lists. There are twenty-three options available for the heating generation and twelve options for the cooling technology.

FORM OF RESULTS

The results are presented on three worksheets, 4. to 6.

Heating and cooling load worksheet

The "Heating and Cooling Load" worksheet is a report that summarises all the characteristics of the site conditions and the parameters entered by the user. The output for the building design heating and cooling loads as well as the building heating and cooling energy demands are also shown. In addition, the model calculates the corresponding exergy quantity for each variable by using a quality factor depending on outside and inside air conditions. The quality factor for the design exergy load is calculated using a constant design temperature. The quality factor for the exergy demand is calculated using variable temperature bins.

Heating worksheet

The "Heating" worksheet is a report that summarises the heating application assessment from both the energy and exergy situations. All the components of the heating process are indicated, as selected by the user, with their characteristics and estimated parameters. The worksheet produces the energy and exergy analyses as flow patterns along the different subsystems. These analyses are presented in two formats, as tables and curves in the provided figure. The extent of the exergy losses in each subsystem can be deduced from the figure (see Figure 16).

Comparison of Exergy Consumption Patterns

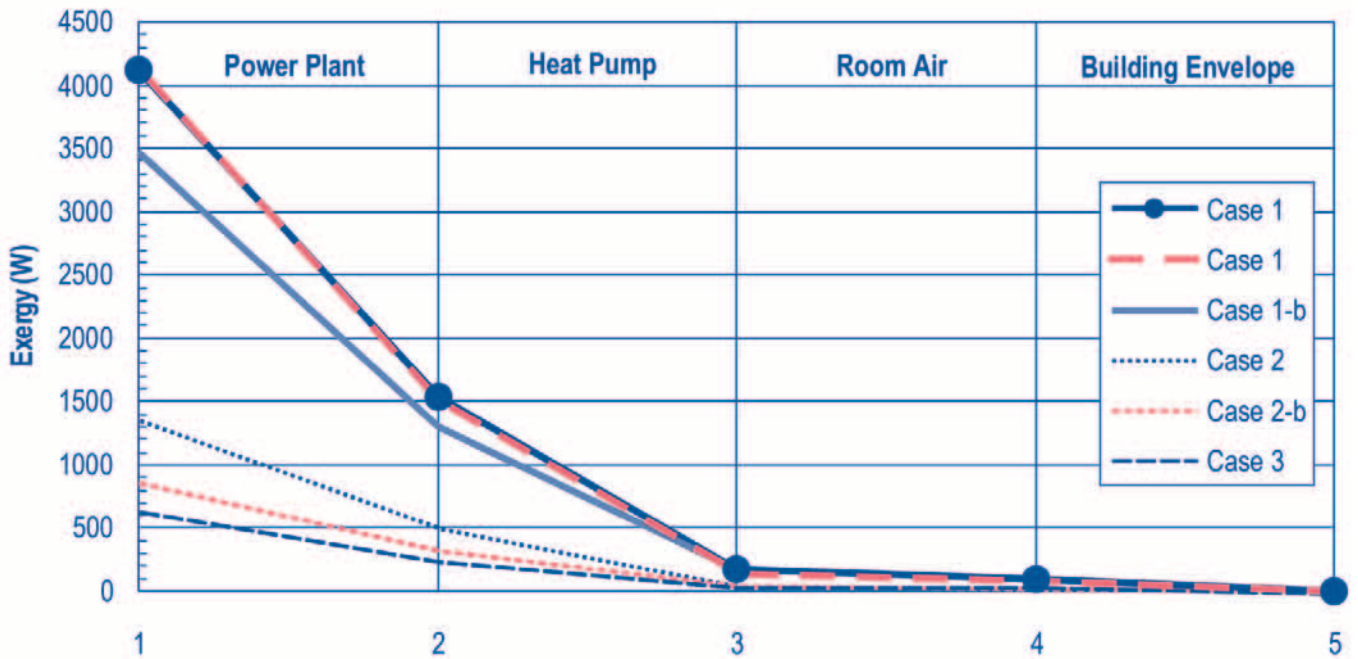

Case 1	Base Case - Moderate Thermal Insulation of Building Envelope, Internal Shading Devices
Case 1-b	Improved COP Coefficient
Case 2	Improved Thermal Insulation, External Shading Devices
Case 2-b	Improved Thermal Insulation, External Shading Devices, Improved Electric Lighting
Case 3	Improved Thermal Insulation, COP and Electric Lighting, External Shading Devices

Figure 16. Example of the output of the Pre-Design Tool. This is a part of the "Cooling" worksheet. In addition to these curves, the results are presented in table format. (Hammache and Shukuya 2004)

Cooling worksheet

Similarly to the "Heating" worksheet, the "Cooling" worksheet is a report that summarises the cooling application assessment from both the energy and exergy situations. All the components of the cooling process are indicated, as selected by the user, with their characteristics and estimated parameters. The

worksheet produces the energy and exergy analyses as flow patterns along the different subsystems. These analyses are presented in two formats, as tables and curves in the provided figure. The extent of the exergy losses in each subsystem can be deduced from the figure (see Figure 16).

4. CONCEPTS AND TECHNOLOGIES

The LowEx database in chapter 4 of the Guidebook consists of sixty-two information sheets, which describe the technologies; their basic principles, technical risks and benefits, advantages, limitations and state-of-art (commercially available, prototype or innovative concept). The idea is to give a quick overview of the possibilities and limitations of the technologies. Some system concepts, which are compiled with these components are presented in section 4.3 of the Guidebook.

For future buildings, a minimum of energy at a very low level of temperature difference between the system and the room should be used for thermal conditioning. In this way a maximum of high quality energy (exergy) could be saved.

The big efforts made in the field of energy saving in buildings by constructing well-insulated and tight envelopes, sufficient window shading and the use of

thermal storage result to a much better usage of the energy. But there is still a big saving potential left. To make the energy use in buildings even more efficient, new low temperature heating and cooling systems are required. The components and systems presented in chapter 4 of the Guidebook show a step further in this direction.

SUMMARY TABLE OF THE LOWEX TECHNOLOGIES

On the following pages, a summary table of the LowEx technologies is presented, with some key information of the components.

At the CD-ROM there is a link to the case, where the technology has been

used. There is also a search function, with which the technologies can be sorted by different parameters. There are links from the summary table to the data sheets.

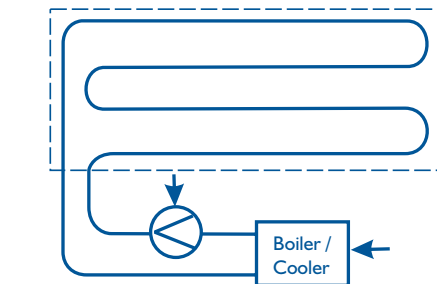
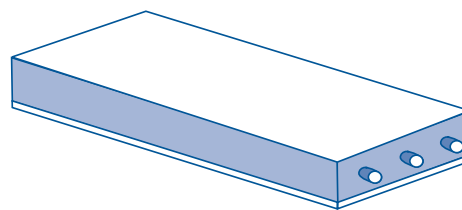

S.1.1

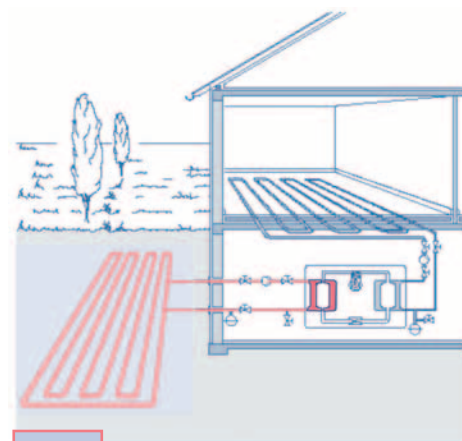

G.2.1

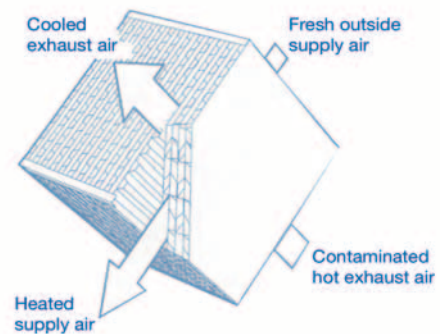

A.1.1

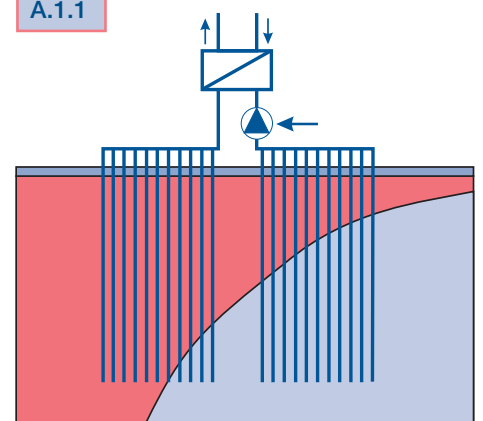

T.1.1



D.1.1

Figure 17. Examples of LowEx technologies.

Table 1. Summary table of the LowEx technologies.

No.	WHAT ?	Suitable for				State of the art			Costs	Cooling temp. [°C] 0 100	Heating temp. [°C] 0 100
		Residential	Non-residential	New	Retrofit	Concept	Experimental	Commercial			
S SURFACE HEATING AND COOLING											
S.1 Floor heating											
S.1.1	Embedded coils in slabs		X	X				X		10-15	25-30
S.1.2	Coils in surface layers	X	X	X	X			X		16-20	28-35
S.1.3	Hollow core slabs		X	X	X			X	→	15-18	25-30
S.1.4	Suspended floors	X	X	X				X	→	16-20	30-40
S.1.5	Phase change in floor heating	X	X	X	X		X		↗	-	25-50
S.2 Wall heating and cooling											
S.2.1	Pipes in surface layers (wet/half wet, mounted)	X	X	X	X			X		10-15	25-50
S.2.2	Pipes in surface layers (half-dry embedded)	X	X	X				X		10-15	25-50
S.2.3	Pipes in surface layers (wet, embedded)	X	X	X				X		10-15	25-50
S.2.4	Pipes in surface layers (dry systems)	X	X	X	X			X		10-15	25-50
S.2.5	Double walls	X	X	X	X	X			↗	10-15	25-50
S.2.6	Dynamic insulation	X	X	X	X			X	↗		25-50
S.2.7	Capillary tubes	X	X	X	X			X	↗	10-15	25-50
S.3 Ceiling cooling and heating											
S.3.1	Radiative panel	X	X	X	X			X	→	10-15	25-50
S.3.2	Cooling beams		X	X	X			X	→	10-15	25-50
S.3.3	Ceiling integrated system	X	X	X	X			X		10-15	25-50
S.3.4	Evaporative roof surfaces		X	X	X			X		15-20	-
S.3.5	Ceiling panel cooling by double-roofing with water spray	X		X	X	X	X			Wet bulb temperature	-
S.4 Local heaters											
S.4.1	Low temperature radiators/convectors	X	X	X	X			X	→	-	30-50
S.4.2	Radiators integrated in the interior design		X		X	X		X	→	10-20	20-40
S.4.3	High temperature radiators	X	X	X	X			X		-	80-130
S.4.4	Base board heaters	X	X	X	X			X		-	40-95
S.4.5	Transparent insulation	X	X	X	X			X	↗		
A AIR HEATING AND COOLING											
A.1 Air to air heat exchangers											
A.1.1	Sensible only heat exchangers / Recuperator	X	X	X	X			X	→		40-95
A.1.2	Counter flow air to air heat exchangers/ Recuperator	X	X	X	X			X	→	10-15	20-50
A.1.3	Total (latent) heat exchangers / Regenerator		X	X	X			X	↗		25-50
A.1.4	Altering heat exchangers		X	X	X			X	→		40-95
A.2 Water to air heat exchangers											
A.2.1	Supply air conditioning	X	X	X	X			X	↗		40-90
A.2.2	Fan coil units	X	X	X	X			X		10-15	25-30
A.3 Steam / vapour to air heat exchangers											
A.3.1	Supply air conditioning	X	X	X	X			X	↗	-	100-120
A.4 Other heat exchangers											
A.4.1	Supply air façade		X	X	X			X	→		20-100
A.4.2	Evaporative cooling	X	X	X	X			X			-

No.	WHAT ?	Suitable for				State of the art			Costs	Cooling temp. [°C] 0 100	Heating temp. [°C] 0 100
		Residential	Non-residential	New	Retrofit	Concept	Experimental	Commercial			
A.5 Passive systems											
A.5.1	Atria		X	X				X	→		
A.5.2	Solar chimneys		X	X				X	↗		
G GENERATION / CONVERSION OF COLD AND HEAT											
G.1 Boiler											
G.1.1	Condensing boilers	X	X	X	X			X	→	-	
G.1.2	Pulsating gas boiler	X		X	X			X	→	-	50-80
G.2 Ground heat											
G.2.1	Ground coils	X	X	X				X	→	8-18	-
G.2.2	Bore hole	X	X	X	X			X	→	8-18	18-22
G.2.3	Slab on ground		X	X				X	↗	16-22	-
G.3 Heat pumps											
G.3.1	Compressor heat pumps	X	X	X	X			X	→	10-15	25-50
G.3.2	Absorption heat pumps		X	X	X			X	↗	10-15	-
G.4 Solar collectors											
G.4.1	Flat plate collectors	X	X	X	X			X	→	-	20-80
G.4.2	Evacuated tube collectors	X	X	X	X			X	↗	-	20-120
G.4.3	Unglazed flat-plate collectors	X		X	X			X	→	-	20-80
G.5 Combined heat and power generation											
G.5.1	Cogeneration units with gas motor	X	X	X	X			X	→	-	80-90
G.5.2	Cogeneration units with microturbines		X	X			X		↗	-	
G.5.3	Cogeneration units with stirling motor		X	X			X		↗	-	
G.6 Fuel cells											
G.6.1	Fuel cells	X	X	X	X		X	X	↗	-	
G.7 Biological systems / Metabolic											
G.7.1	Bacteria		X	X	X	X			→	-	20-60
G.7.2	Animals	X	X	X		X			→	-	20-35
G.7.3	Plants	X	X	X	X		X		→	20-25	-
T THERMAL STORAGE											
T.1 Seasonal storage											
T.1.1	Ground / rock storage	X	X	X	X			X	→	8-20	40-100
T.1.2	Earth duct storage	X	X	X	X			X	→	10-15	45-75
T.1.3	Hot water storage	X	X	X	X			X	↗	-	35-95
T.1.4	Phase change thermal storage		X	X	X		X	X	↗		
T.2 Short term storage											
T.2.1	Buffer storage tank	X	X	X	X			X	→	5-15	40-90
T.2.2	Domestic hot water tank	X		X	X			X	→		45-60
D DISTRIBUTION											
D.1 Transfer medium											
D.1.1	Air	X	X	X	X			X	→		
D.1.2	Water	X	X	X	X			X	→		
D.1.3	Thermera® heat carrier	X	X	X	X			X			
D.1.4	Glycol	X	X	X	X			X			
D.2 Community systems											
D.2.1	District heating	X	X	X	X			X		-	65-115
D.2.2	District cooling	X	X	X	X		X	X		6-10	-

In recent years system solutions have appeared where heating and cooling is carried out in a holistic system solution where the energy use is planned in a wider and more general perspective.

LOWEX SYSTEM CONCEPTS

One example of a LowEx system is the use of boreholes to provide cooling in summer. This was apparently a very promising method but in some cases the borehole would gradually over the years become warmer and above the temperatures that could be used for direct cooling in a rational way. By also extracting heat in winter with a heat pump, the heat balance of the hole is restored and the system solution becomes sustainable in time. In most cases where exergy is being consumed at different temperature levels in the same system a thorough system study in an exergy perspective can lead to substantial savings.

THERMONET SYSTEM CONCEPT FOR HEATING AND COOLING

ThermoNet system can be applied to a variety of building types including hospitals, swimming halls, offices, industrial buildings,

residential high-rise buildings etc. An application of ThermoNet system for grocery stores (Figure 17) is presented in chapter 4.3.1 of the Guidebook.

The exploitation of condensation heat, waste heat, and excess energy in a ThermoNet system is based on two factors: an air heating system that utilises low temperature technology, and efficient energy recovery. By applying ThermoNet technology, the consumption of purchased energy may be cut by more than one half when compared to conventional solutions, and electrical consumption may be reduced to one third. The ThermoNet low temperature system is able to utilise district heating return water from other properties, reducing peak loads by 60-70 %.

Figure 18. A LowEx system for a grocery store.

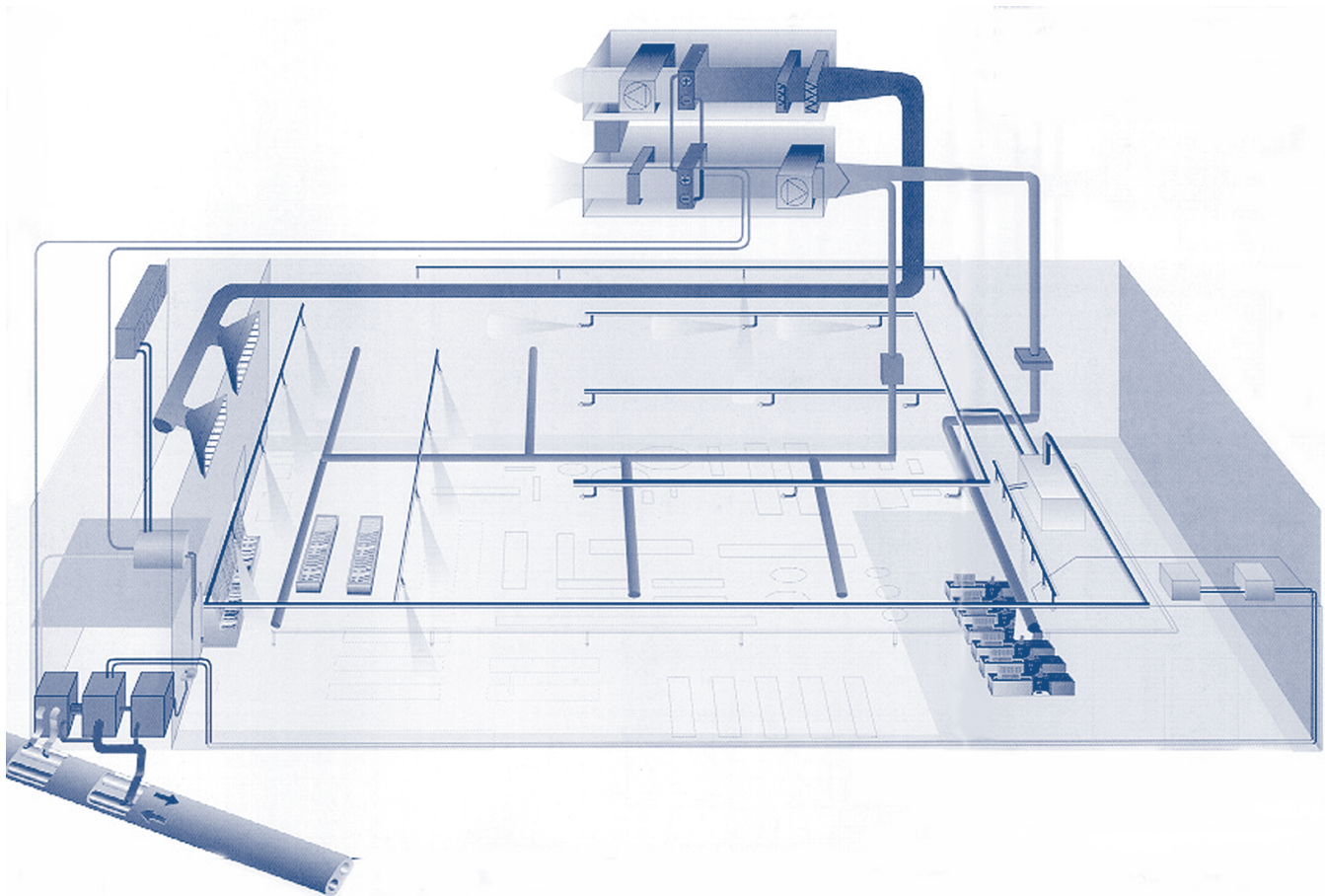
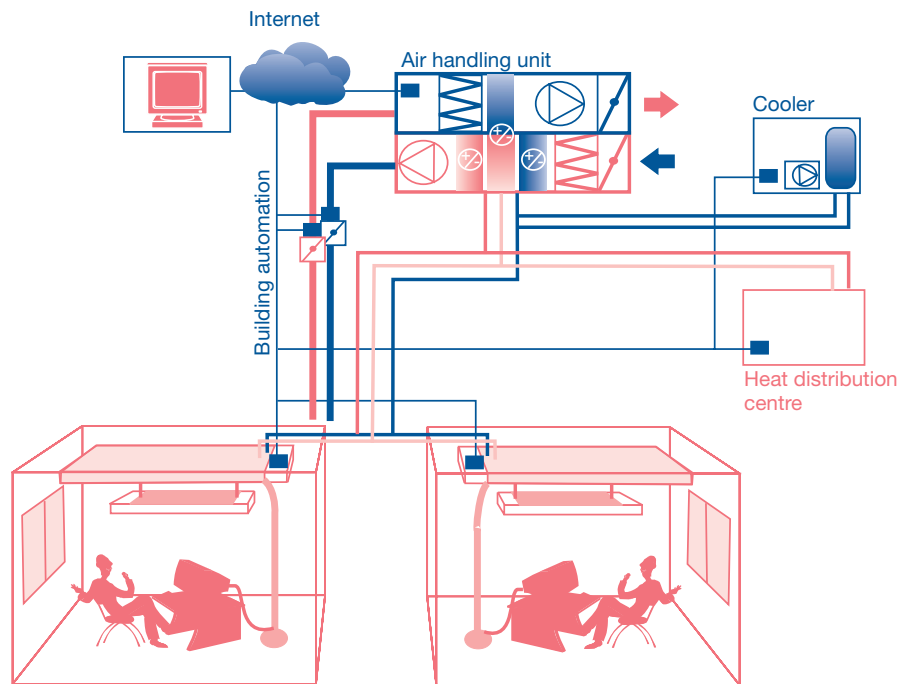

Figure 19. Main components of the ARE Sensus system.



HEATING AND COOLING WITH ARE SENSUS

The use of Sensus® building services system (Figure 18) in an office building is described in chapter 4.3.2 of the Guidebook. The exergy consumption of the Sensus® system is lower than in comparable high-standard systems, which also decreases environmental impact during use.

Office ventilation employs a Sensus® ventilation unit connected to the Sensus panels with a three-pipe network. The ventilation units utilise surplus heat collected from the rooms with the cooling water system for the heating of intake air whenever heating is needed for the intake air. This conserves heating exergy. The ventilation machine also has an efficient rotating heat collector for the exhaust air (over 70 % heat efficiency).

The Sensus® ventilation unit utilises outdoor air for cooling the cooling water for the rooms when outdoor temperature is sufficiently low (under +12–14 °C). This free cooling carried out with ventilation units operates alongside mechanical cooling when necessary. It has a considerably longer annual period of utilisation (over half of the year's working hours) than conventional free cooling. This lowers the electricity consumption of cooling unit in the Sensus® system in comparison with conventional solutions.

CEILING COOLING WITH WELL WATER

An other system concept described in chapter 4 of the Guidebook is a ceiling radiant cooling system using well water, and with outdoor sun shading on the South-facing window. The ceiling radiant cooling system is installed in the living room (Figure

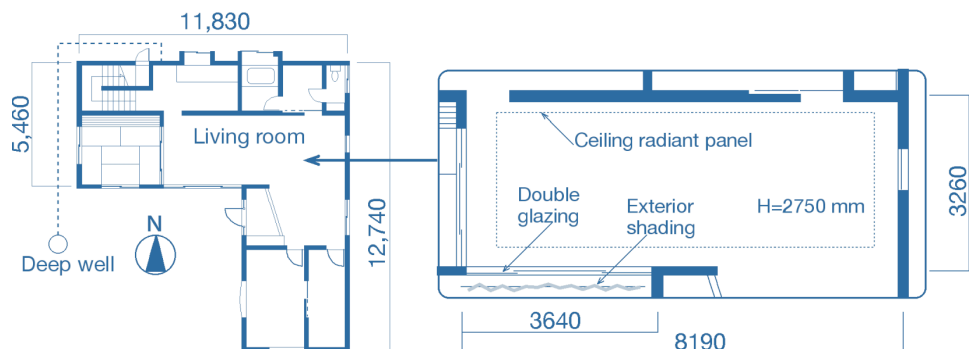

Figure 20. The house equipped with ceiling radiant cooling system using well water (Asada and Takeda 2002).

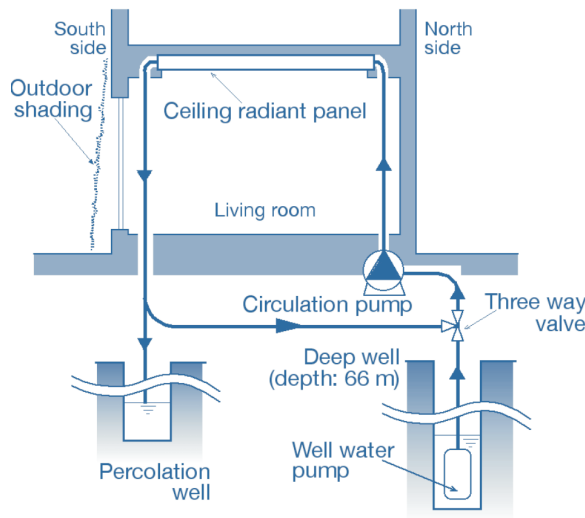

Figure 21. Components and well water flow (Asada and Takeda 2002).

20, right hand side) of a two-storey wooden house, which has well-insulated exterior walls and double-glazing windows. The living room window (3.6 m x 2.2 m) faces south.

Figure 21 schematically shows major components and well water flow in the ceiling radiant cooling system: deep well (depth: 66 m), well water pump, three-way valve, circulation pump, ceiling radiant panel (aluminum panel with embedded pipes), and percolation well. Water from the deep well is pumped up and mixed with return water from the ceiling radiant panel by the three-way valve to maintain the temperature at the set point. The circulation pump enables this mixed water to run within the panel and cool it. A portion of the return water is sent to the three-way valve and the rest is discarded via the percolation well.

INNOVATIVE HEATING CONCEPT

The energy source for this system concept is ground heat. This heat is extracted through a heat pump. The emission system is, instead of a conventional floor heating system, a floor heating with phase change (chapter 4 in the Guidebook, data sheet S.1.5). This floor heating system has a phase change material (PCM) that can be utilised to store the energy from a solar collector during the day. During the night the energy is released and warms up the room. The same floor heating system could also be used the other way around, “charging itself” during the night and releasing the heat during the day. This could be of use when using a heat pump.

The heat pump uses electricity, about one third of its supplied energy amount. Looking at the electricity distribution system, there is an “overload” in the network during the night. The system is designed to cover the peaks that occur during the day. The best thing for the energy production point of view would be to have an even consumption curve. By using electricity during night time we contribute to making this curve more even, and we get economically compensated for this with the right kind of electricity contract.

The exergy analysis of such a system looks just like the analysis of a system with a traditional floor heating system (Figure 22).

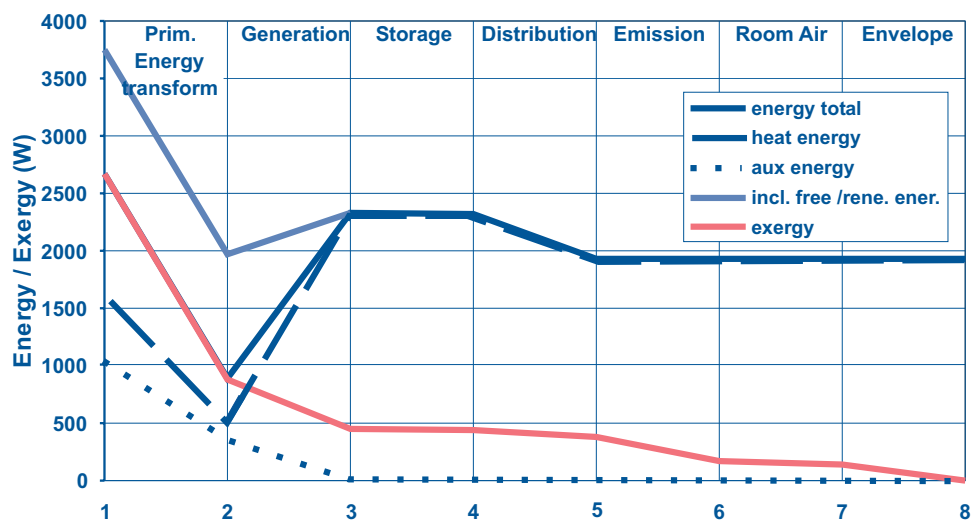
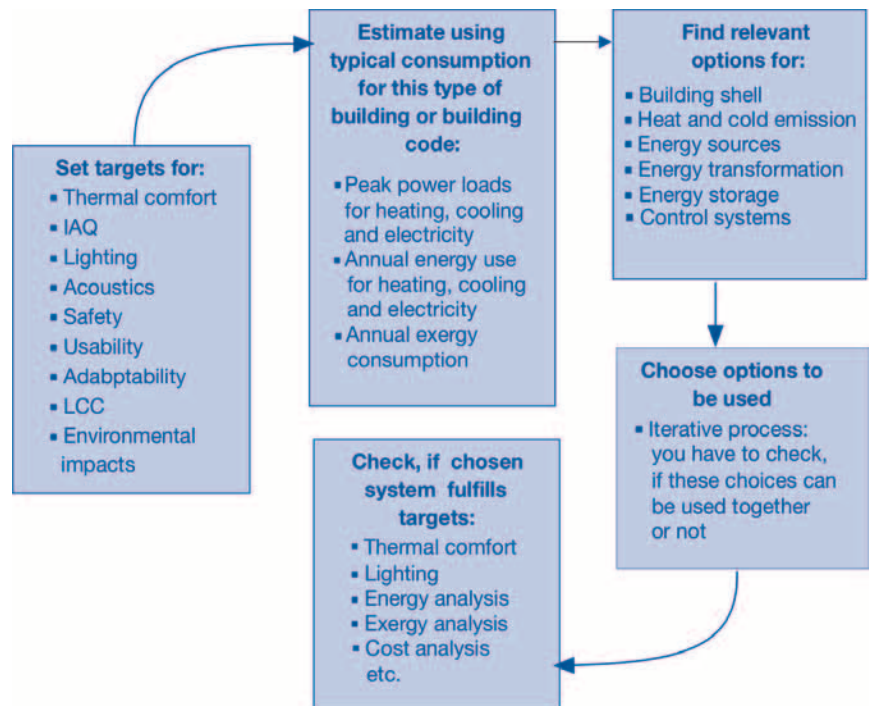

Figure 22. Exergy analysis of a floor heating system using a heat pump as energy generator.

The aim of the design process presented here is to make energy efficient buildings that can provide the occupants with comfortable, clean and healthy environment. The building should always be designed as a whole, i.e. the different parts should work together optimally and not obstruct each others operation.

STRATEGIES FOR DESIGN OF LOW EXERGY SYSTEMS IN BUILDINGS



The design process is or at least should be an iterative process. There will always be a need to go back to earlier step and revise the choices made. The design process is described in Figure 23. The terms in the boxes are more explained in chapter 4.4 of the Guidebook.

Figure 23. The design process of a building as a system.

Figure 24. Acoustics played an important role in design of the Sibelius Hall in Lahti, Finland (see Case FIN 2 in the Guidebook).

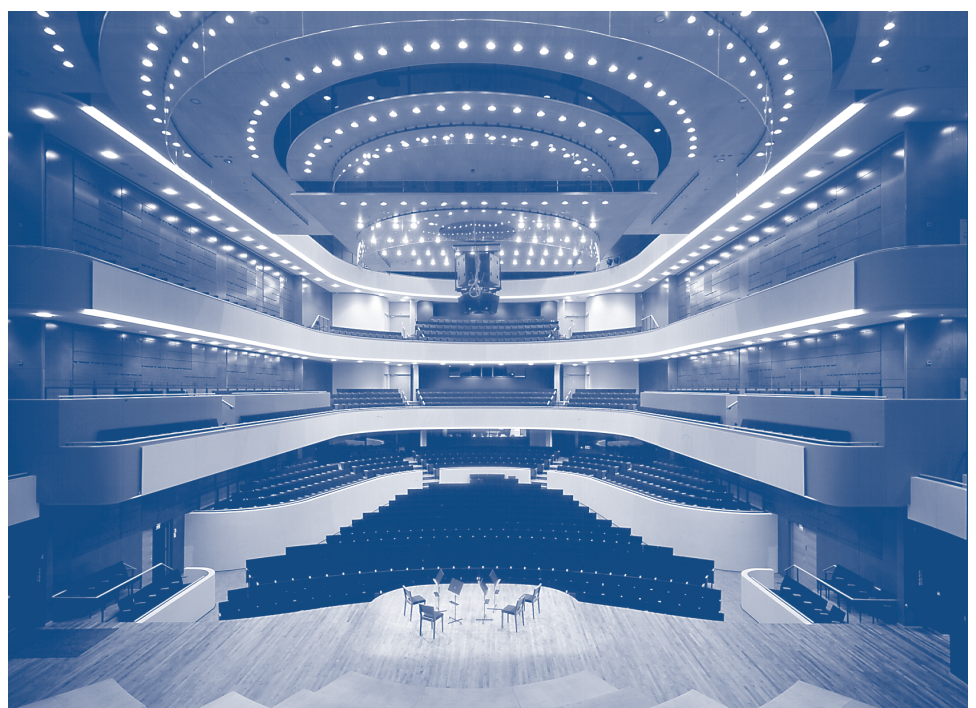

5. EXAMPLES OF LOWEX BUILDINGS

In chapter 5 of the Guidebook, examples of the use of LowEx systems in various buildings are presented. Together with the findings from a literature study and an occupant survey, which are also presented in this chapter, the case examples give strong evidence that in addition to the desired heating or cooling effect, LowEx systems can provide occupants with a comfortable, clean and healthy environment.

The case examples show the wide variety of applications of low exergy (LowEx) systems. They also demonstrate the flexibility of the systems with regard to the energy source. There are examples of LowEx systems in dwellings and offices, but also in a museum, a church and a concert hall. In these examples there are systems that use heating or cooling energy from the sun, the ground, a district heating network as well as an electricity or gas network.

Findings from the literature (chapter 5.4.1 in the Guidebook) show that the application of LowEx systems provides many additional benefits besides energy supply, such as improved thermal comfort, improved indoor air quality and reduced energy consumption.

The Dutch occupant survey (chapter 5.4.2 in the Guidebook) shows that all low temperature systems are well received. In particular, the occupants found the indoor climate to be significantly better in dwellings with floor and wall heating compared to their previous dwellings. The main disadvantage was controllability. The advantages and disadvantages, mentioned by the occupants in the survey, are similar to results in the literature.

The experiences from the case examples also agree with the findings from the literature: In addition to the desired heating or cooling effect, LowEx systems can provide occupants with a comfortable, clean and healthy environment.

SUMMARY TABLE OF CASE STUDIES

Demonstration projects have been submitted by all participants: 27 examples plus 3 extra cases from the LowExx (LowEx systems in existing and historical buildings) group. With 30 cases, distributed over new and existing buildings, residential and non-residential buildings with various technologies and emission systems, this gives a good overview of the application of LowEx systems for heating and cooling of buildings. Table 2 and Table 3 show the distribution of the cases. Most cases are new non-residential buildings. Floor heating is the most commonly used emission system in the case buildings. Most of the cases are low temperature heating cases; in only 12 cases high temperature cooling is applied. From the table on the following page you can get an overview of the cases. In chapter 5.2 of the Guidebook the cases are presented in more detail on 2 to 4 pages each.

The first page of each fact sheet gives an overview on the project by a general description accompanied with a picture or drawing of the building. The heating and cooling system of the building is characterised with a list of keywords that are picked up from a selection. Some general data about the project team and the building is given. The installations are described with more detail in the following pages by words

and schemes. Measurement results are presented where appropriate.

In the Guidebook, cases are presented by country in alphabetical order. On the first page of each fact sheet, there is a map showing the locations of different case buildings in that country.

Table 2. Distribution of building types.

Type of building	Number of cases
New residential	9
Existing residential	4
New non-residential	10
Existing non-residential	4+3

Table 3. Distribution of emission systems.

Emission system	Number of cases
LT floor	15
LT wall	7
LT ceiling	8
LT radiator/conv	9
LT air	9
Cooling beams/radiative panels	2
Activated thermal slab	2
Combined systems	15

Table 4. Summary table of case studies.

Name	Case	Building type				Heating/Cooling generation	Heating/Cooling emission
		Res.	Non-res.	New	Retro.		
Bregenz Art Museum	AUT 1		x	x		Boiler, ground cooling	Floor, wall, ceiling
Bregenz Office	AUT 2		x	x		Boiler, ground cooling	Floor, wall
Downey Road	CAN 1		x	x		Local central heating plant, local central chiller plant	Ceiling panels
Blomsted Hall	FIN 1		x		x	DH, free cooling, chillers	Ceiling, air
Sibelius Hall	FIN 2		x	x		DH, DC	Air
Käärkartano	FIN 3	x		x		Central heat pump, solar	Floor
Hotel de Croy	FRA 1		x		x	DH, heat pump	Ceiling
Nestle Head Office	FRA 2		x		x	Boiler, cooling tower	Ceiling, air
ZUB	DEU 1		x	x		DH, ground cooling	Floor, ceiling
Zander Office	DEU 2		x	x		Boiler, heat pump, solar etc.	Floor, ceiling, air
NTUA Campus	GRC 1		x		x	Water and ground heat pumps	Fan-coils
Langadas	GRC 2		x		x	Central heat pump	Fan-coils
Casa Intelligente	ITA 1	x		x		Boiler, central heat pump	Floor
PS Orangerie	JPN 1		x		x	Ground heat pump, water spraying	Radiators
Hamamatsu	JPN 2		x	x		Solar, gas boiler, sky	Floor, air
YIES	JPN 3		x	x		Central heat pump, solar, ground	Floor, air
Sustainable Eco House	JPN 4	x		x		Central heat pump, solar, water spraying	Air, Floor
IDIC	JPN 5		x	x		Ground water heat pump	Radiators
Amboise	NLD 1	x		x		Condensing boiler, solar	a. Radiators b. Wall
Carisven	NLD 2	x		x		Condensing boiler, solar	Wall
Molengronde	NLD 3	x		x		Central heat pump	Floor, wall
Weerselostraat	NLD 4	x		x		Heat pump	Radiators, floor
RWS Office	NLD 5		x	x		Heat pump, solar	Floor, wall
Lienaertstraat	NLD 6	x			x	Cogeneration, heat pump, solar, condensing boiler	LT radiators
Klosterenga	NOR 1	x		x		Central heat pump, solar	Floor
House from 1917	NOR 2	x			x	Electricity	Floor, wall, ceiling
Villa Wählin	SWE 1	x		x		Heat pump	Floor, air
Villa Akander	SWE 2	x			x	Boiler	Floor, radiators
Katrineholm	SWE 3	x			x	Heat pump	Radiators, floor, air
Teharje	SVN 1		x		x	Boiler	Wall

RETROFITS

The existing building stock is very important to focus on, the renewal of the building stock is very slow, and if we neglect the possibilities for LowEx systems in the existing buildings, the total effect will not be as large as we hope for.

There are special issues to take in to consideration when we are talking about applying LowEx systems in existing buildings, these will be reviewed here. Some examples of LowEx systems in existing buildings are presented in the case examples of the Guidebook (11 retrofit cases), one example is a historical building with a cultural heritage, which means an even greater challenge.

The age of the building is not such an important issue when considering the possibilities for applying LowEx systems. The important aspects are the degree of protection of the building, the building type, the scale of renovation, replacement of installation and the type of LowEx system to be applied.

A good timing is very important when trying to market LowEx systems into retrofits. When a renovation is done anyway, it is much easier and cheaper to

install a new heating/cooling system than if you start a whole renovation just to change the system. In residential houses, it is very common that when the house owner changes, some renovation is done. Therefore, some marketing of LowEx systems should be made at the time of the purchase of the house.

Even though the low temperature heating systems are functional systems with lots of advantages, we need to keep in mind that when we are talking about retrofits, there are also some technical limitations. In old houses the walls are not always that good, and one can encounter really poor U-values. If this is the case, floor heating is not efficient enough to meet the heating demand. The exergy analysis tools developed in the Annex 37 group can help with this problem (Chapter 3). They calculate if the system is efficient enough to heat the house. Another problem could be that we can not make the floor any higher than it is. For this problem, there are solutions with very thin constructions, only a bit more than 2 cm for the whole construction (chapter 4 in the Guidebook, data sheet S.1.2).

OPPORTUNITIES AND THREATS

Reasons for applying LowEx:

- Esthetical
- Improved indoor climate/comfort
- Conservation of cultural heritage
- Lower energy use
- Use of renewable energy
- Energy efficiency
- Integration of heating and cooling systems.

Limitations/Threats for applying LowEx:

- Low price of fossil fuels, low electricity prices
- Availability on the market/market price
- No checking of regulations
- Comfort criteria isn't that high in existing houses as in new ones
- Stick to tradition
- Lack of knowledge

Opportunities for applying LowEx:

- Large scale renovation: combination with other measures:
 - acoustic matters
 - upgrading the building or a part of the building more luxury
- Cooling can be added
- Improving indoor climate
- Adjusting office to modern IAQ standards: increased productivity of employees
- Moisture problems-protection of art work, preventive conservation
- Extended use of the building
- Flexibility
 - CO₂ potential
 - uncertainty of energy prices
- Awareness is raising
- Energy Performance Standard (EPS) based on primary energy

ADVANTAGES AND LIMITATIONS OF LOW EXERGY SYSTEMS

IMPACT ON IAQ, THERMAL COMFORT AND ENERGY CONSUMPTION

The literature study presented in chapter 5.4.1 of the Guidebook was conducted by Eijdens et al. (2000), as a part of a Dutch program for the implementation of Low Temperature Heating (LTH) systems in buildings, which was initiated by the Netherlands Agency for Energy and the Environment (NOVEM). The primary goal of the program was to enable the use of Low Valued Energy as a heating source. Major savings in energy consumption can be realised by fully utilising the potential of Low Valued Energy.

The study by Eijdens and Boerstra (1999) shows that lowering the temperatures for heat distribution systems, besides the possibilities of savings in energy supply, gives additional benefits such as:

- Thermal Comfort increases in many respects (greater share of radiant heat transfer, less temperature gradients, better floor contact temperature, less draught and air turbulence);
- The IAQ is also positively influenced (less dust singe and house dust mites, less stuffiness and odours through lower air temperature, less suspended particles);
- In addition to the ability to use Low Valued Energy, savings are gained from better performances of boilers and heat pumps, less piping heat loss and less ventilation losses.

Other benefits might occur, like avoidance of burning risk, extra space due to the absence of radiators, avoidance of mould growth, etc. Many disadvantages can be avoided by means of a proper design and compensating measures. Arguments against LTH systems often appear to be based on negative experiences in the past (bad design or insulation) or a lack of knowledge.

By highlighting these additional benefits, an easier introduction of LTH systems might occur. Application on a broader scale will also lower the prices of these systems.

OCCUPANTS' EXPERIENCES ON LOW TEMPERATURE HEATING SYSTEMS

One of the critical success factors for the implementation of Low Temperature (LT) heating systems in residential buildings is the way these systems are viewed and accepted by the occupants. At the moment costs for such systems for dwellings are higher than those for traditional High Temperature (HT) systems while energy savings in some cases are only marginal. This means that LT systems must have some additional qualitative benefits for occupants (thermal comfort, indoor air quality, safety, etc.). The overall performance of LT heating systems must be at least equal or preferably better than that of traditional HT systems.

An occupant survey was conducted in the Netherlands in October 1999 among 409 households with LT heating systems. It is described in chapter 5.4.2 of the Guidebook. The first objective was to make an inventory of the experiences of occupants with LT systems, and to see if these systems fulfil their expectations. These results can also convey information about possible obstacles in further market introduction.

Results of this survey can not be generalised for the total Dutch new building stock. All studied projects were demonstration projects for LT systems.

Occupants were asked about their opinion of the indoor climate in terms of whether or not it had improved in relation to the indoor climate in their previous dwelling. Notable was the very positive score for floor and wall heating (>70 %). Up to 61 % of the occupants with LT radiators did not notice any difference. The results for wall heating do not differ from previous occupant surveys (demonstration projects for sustainable building – Silvester et al. 2000).

Occupants did not initially choose dwellings based on environmental factors. However, for 58 % the environmental aspect was important in the final selection of their dwelling. Floor heating is an

important factor in the decision-making but is not considered as a particular energy or environmental measure. Therefore, additional information and communication concerning the energy efficiency of LT systems is recommended.

A majority of the respondents with LT radiators did not have any idea that they have an LT system. On one hand this is positive because this suggests that there seems to be no difference (disadvantage) in comparison with more conventional systems. However, further communication about the energy efficiency of these systems could still be recommended.

There was a significant difference between the set points of the thermostats between the different LT systems during winter nights (Table 5). Occupants with floor and wall heating applied a small

Table 5. Set point temperatures.

	T-average (°C) winter evening	T-average (°C) winter night
Floor heating	19.9	17.8
Wall heating	20.3	17.6
LT-radiators	20.6	15.1

temperature difference to compensate for night set back.

Occupants would also be interested in learning how to use their heating appliances to reach an optimal balance between energy use and thermal comfort. About 50 % of the occupants did not use heating in bedrooms during wintertime.

The advantages and disadvantages, mentioned by the occupants in this survey (Table 6) back up results from previous research. This survey also confirms the results of the literature review on side effects of low exergy emission systems (chapter 5.4.1 of the Guidebook). Especially the occupants' perception of indoor air quality, thermal comfort, slowness and controllability of some LT-systems confirm results from previous studies.

Although LT-systems are very well accepted and appreciated (Figure 25), there are some negative aspects and disadvantages that should be taken into account and solved. These are for example system controllability per room (floor and wall heating) and the size, design and installation of LT radiators.

All systems were very well received by the occupants. Particularly indoor climate has improved a lot in dwellings with floor and wall heating in relation to their previous situations (Figure 26). For LT radiators the occupants found no difference in the indoor climate compared to their previous dwellings. The main disadvantage is the poor controllability, especially with floor and wall heating; 30 to 40 % of the occupants mention poor controllability as a disadvantage.

Figure 25. Do you think that LT system gives pleasant or unpleasant heat?

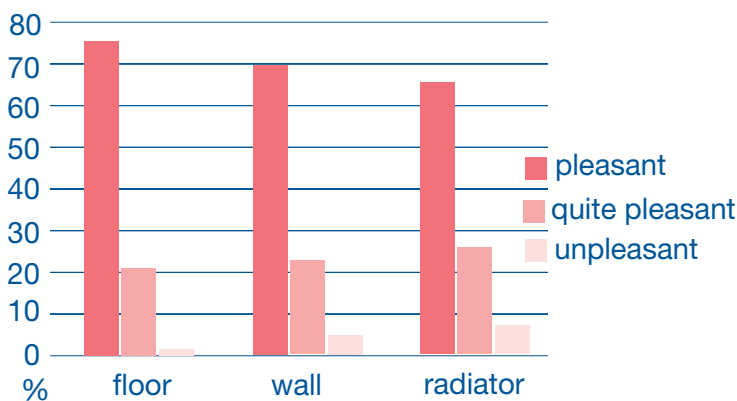

Figure 26. Do you think that LT system gives an improvement of the indoor climate or not?

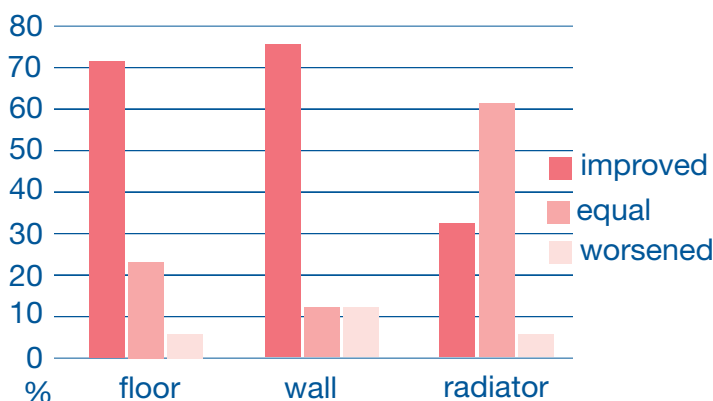

Table 6. The survey gives a good indication of the specific advantages and disadvantages of each system.

LT-system	Advantage	Disadvantage
Floor heating	<ul style="list-style-type: none"> - No radiators - Equal distribution of heat - Thermal comfort - No cold feet 	<ul style="list-style-type: none"> - Slow heating up - Limitation selection of floor covering
Wall heating	<ul style="list-style-type: none"> - No radiators - Equal distribution of heat - Thermal comfort 	<ul style="list-style-type: none"> - Slow heating up
LT-radiators		<ul style="list-style-type: none"> - Much space needed for radiators

EXPERIENCES FROM CASE STUDIES

User experiences

Several case studies include feedback from occupants about their experiences with LowEx heating or cooling systems in their buildings.

This information is available for the following cases:

- Netherlands: Amboise, Weerselostraat, Molengronden, Rijkswaterstaat
- Canada: Downey Road
- France: Hotel de Croy
- Japan: IDIC Research Centre, Sustainable Eco-house, YIES, Kumamoto
- Sweden: Villa Akander, Villa Wahlin
- Germany: ZUB Centre for sustainable Building

In general, the feedback from users has been very positive. In all cases the occupants were satisfied with the installed LowEx systems.

Residential buildings

In the existing dwelling Villa Akander, occupants felt that the thermal comfort had significantly increased after the installation of the floor heating system. The Kawasaki Sustainable Eco House provides a high level of comfort for the occupants in the heating as well as the cooling case (fresh and dry air). Children living in the neighbourhood like to visit this house because of its comfort level. Also the Dutch case studies show that the occupants were satisfied with the LowEx systems. Occupants of the Amboise project mentioned that the wall heating system

played an important part in their decision to buy the house. The occupants also preferred a lower set-point of the thermostat compared to the one they were used to earlier (19 °C in stead of 21 °C). This confirms the assumption that wall heating is equally comfortable at lower air temperatures than radiator heating.

Non-residential buildings

Users of the ZUB-building indicated to be satisfied with the indoor climate in the building. In the cooling case of Hotel de Croy, occupants appreciated the reached comfort and they particularly praised the absence of noise and air movement. IDIC reported a highly satisfying indoor climate both for human occupants as well as for indoor plants. Also Kumamoto occupants stated that the building provides a healthy work environment under different seasonal climates, particularly during the hot and humid summer period. In the YIES building the majority of the occupants claimed to be satisfied, although there were some remarks about the relatively slow heating-up time of the floor heating system.

Finally, a survey among the users of the RWS office in Terneuzen showed significantly higher occupant satisfaction with indoor climate compared to standard offices. There were no complaints at all regarding dry air, air dust, and air quality in general; and significantly fewer complaints concerning eye irritation, temperature fluctuations and overheating.

Measurements

Measurements have been performed in most of the case studies in order to gain a better insight in system temperatures, air and radiant temperatures, heating up time and air temperature distribution (thermal gradient). Also energy (exergy) consumption has been evaluated. More details can be found in the paragraphs describing the case studies in the Guidebook.

Conclusions

The user experiences from the case studies support the findings of the literature review on the “impact on IAQ, thermal comfort and energy consumption” of

LowEx systems described in paragraph 5.4.1 of the Guidebook. The measurements performed in the case studies also coincide with the results of the literature review.

It can therefore be concluded that the experiences from the case studies (measurements as well as user experiences) confirm the conclusions of the literature review.

Interestingly enough, LowEx systems are not only preferable from an exergy point of view, people also seem to appreciate the “softer” heat and coolness of the LowEx systems much more than the traditional heating and cooling solutions.

6. MARKET POSSIBILITIES

This chapter reviews the market situation of LowEx systems in different countries and presents a summary from interviews that have been conducted among the main actors of the building field in different countries. Only the overview and summary are presented in this Summary Report. The country specific market analyses can be found in the Guidebook.



OVERVIEW OF THE MARKET SITUATION

The application of LowEx systems is far more common in new buildings than in existing buildings. For example in The Netherlands and in Norway it is more or less common practise to install low temperature heating- or high temperature cooling systems in new residential buildings. For existing residential buildings it is more of an unknown concept but the trend is, however, positive. In Japan and Canada, hardly any cases with LowEx systems installed in existing residential buildings can be found.

The situation is somewhat similar for non-residential buildings. For these types of buildings, LowEx systems do not seem to be as common in the new building stock as for residential buildings. Table 7 summarises the market situation in nine different countries.

Table 7. Summary of the market situation in different countries.

	CAN	FIN	FRA	DEU	JPN	ITA	NOR	SWE	NLD
Residential									
new	X*	XX	XX	XX*	X*	X*	XXX	X(X)	XXX
existing	-*	X*	(X)*	X*	-*	(X)	X*	X*	X*
Non-Residential									
new	X*	XX	X	XX	X	?	X	XX	XX
existing	-*	X*	(X)*	(X)	X*	X	-	X*	X*

Figure 27. Thermal comfort is important, but people sometimes tolerate incomplete comfort, like this man sitting in an igloo on an ice sofa.

ses the market situation in nine different countries. A higher number of crosses indicates a more common use of LowEx systems, and a positive trend is marked with a star. Please note that information for this table has been collected through discussions with a small number of people from each country, and should therefore be considered indicative.

SUMMARY OF THE MARKET ANALYSES

The market analyses in different countries were conducted as interviews with the main actors in the building field. The target groups for the interviews were: principal contractors, architects, consultants, manufacturers and suppliers, installers and end users.

In order to reach a wider application of LowEx systems, arguments in favour of the use of these systems need to be communicated more clearly for all target groups in most countries. The positive associations need to be supported by good examples gained from the use of LowEx systems. When the additional benefits are reliably presented, people will most probably be willing to accept extra

investment costs. Although thermal comfort is seen as an important factor, in some countries end users are still ready to accept incomplete comfort.

End users are usually not familiar with low temperature (LT) systems, except in Germany where these are quite well known. Manufacturers and suppliers, however, are usually familiar with LT systems. Knowledge of LT systems varies considerably within the other interview groups in different countries and even within the countries. One group that should raise particular concern is the architects

who are unfortunately not very familiar with LTS. This is the group that has great influence in implementing the systems into the market. In addition, although we know that LowEx systems offer some advantages for the architectural design, it seems that the architects are not aware of these advantages.

In general, LowEx systems seem to create very positive associations such as energy efficiency, comfort, soft heating or safety. There were a few comments about suspected comfort problems, but these were exceptional. Some doubts about the functionality and ease-of-use of the systems were expressed. Sometimes the systems are regarded as new and unusual systems, and are therefore seen as something with which to be careful. There are groups that prefer sticking to traditional systems. In many cases LT hating was associated with floor heating, especially by architects but also by other groups and often the systems were associated with renewables. It seems that inadequate information about the systems is the major cause for negative associations.

There is a lot of variation in attitudes towards extra investment costs. In Finland, France and Germany extra costs are less accepted than in Sweden, Netherlands or Norway. In Canada people are mostly willing to pay for the extra benefits offered by the LowEx systems. Extra costs are sometimes accepted also in Japan, when the additional benefits are clearly communicated. In other countries, too, good arguments are needed to change the negative attitudes towards a willingness to make extra investments. In some countries LowEx systems are considered as luxury systems.

In most countries, thermal comfort is seen as a very important factor in building design by all interview groups. Incomplete comfort is, however, tolerated by end users in many countries. It seems that they do not know that they could demand better thermal comfort in their houses. Also, architects often ignore thermal comfort as a target. Controllability is often considered more important than thermal comfort.

Table 8. Summary table of the market analyses.

	Recognition of name LTS	Associations / feelings	Attitude towards extra investments	Appreciation of thermal comfort as a target; strategic significance
CAN	Both + and -, End Users. Architects and Consultants no	Mostly +, comfort, floor heating	Mostly +, Architects -, "Worth extra investment"	Both + and -, more +
FIN	Both + and -, End Users no	Both + and - inadequate knowledge, comfort problems?	Both + and - more -	More + Architects -
FRA	More + than -, End Users no	Both + and - "soft heating", control?	More + than -	Mostly + "Important"
DEU	More + than -, End Users yes!!	More + than - Renewables. "new technology"	Both + and - slightly more -	More + than -
JPN	Both + and -, End Users no	Both + and - Floor heating	Occasionally accepted	More + than +
NOR	More + than -	More + than - Floor heating	More + than - increasingly interesting	More + than - "Also energy costs important"
SWE	Both + and -, Architects no	Both + and - EU and Arch - Floor heating, HP, Renewables	Both + and -	More + than -
NLD	Both + and -, End Users no	Both + and - Floor heating, luxury	Both + and - good arguments needed	Very +
		Yes/positive	Neutral/ inconsistent	No/negative

7. STRATEGIES AND POLICIES

A summary of a review of strategies and policies in different countries is presented in this Summary Report. The country specific reviews can be found in the Guidebook. The review of strategies and policies in different countries shows that there is a common aim to reduce the demand of energy use in buildings. In the future it is obvious that a total approach will be used which takes into account the use of primary energy, the quality of energy as well as environmental impacts. Meanwhile, further reduction of the specific needs for energy use in buildings is recommended.

The focus of the building codes has in many countries been in reducing transmission losses of building envelopes. This aim is still valid and it shall not be forgotten in the future. Requirements for reducing ventilation heat losses have been set only in some countries so far. This aim should be applied in building codes more widely in different countries. Ventilation heat losses are as important as transmission losses. They are even gaining more importance in future, when the transmission losses get smaller due to the better quality of envelopes.

In the review, the quality of energy is very rarely mentioned in the different strategies and policies of the countries. In some countries, however, there are aims to reduce the use of electricity for heating. In Sweden it is prohibited for new buildings, and in Finland the use of electrical heating systems tightens the demand for heat consumption. The primary energy factor is sometimes also used to indicate the difference of quality between energy sources. Similarly, requirements for reducing the use of electricity in buildings have been set only in some countries so far. This aim should be applied in building codes more widely in different countries. Building services systems and equipment should be developed further, taking into account their electrical efficiency.

High quality energy should not be used for heating and cooling in buildings without a thorough investigation of suitable alternatives. For instance in Germany and

the Netherlands the positive impacts of low temperature heating have already been taken into account in building energy performance calculations.

The new European energy performance directive for buildings will help steering the national codes into the right direction. It still leaves relatively free hands to the individual countries to decide how the targets will be realised in practice. It considers only new buildings and renovations of large existing buildings (over 1000 m²). This still leaves out a large part of the building stock. In addition, these regulations are only binding on the European countries.

Renewables are supported in many countries. The use of renewable sources is usually rewarded in the calculation methods. This is also required by the new European energy performance directive for buildings. Poor insulation or ventilation energy losses can usually be compensated by the use of renewables.

One should not forget that rational passive design is a prerequisite for realising low exergy systems for the heating and cooling of buildings. All improvements in the energy performance of the building will work in favor of LowEx systems, because they can provide moderate heat or cold demand easier. Also, as we saw in Chapter 2, the reduction of exergy use is most effectively done by a rational passive design of the building.

8. CONCLUSIONS

Exergy defines the quality of energy and is an important tool for designing and assessing different heating and cooling systems. In Annex 37, 'low exergy (or LowEx) systems' are defined as heating or cooling systems that allow the use of low valued energy as the energy source. In practice, this means systems that provide heating or cooling energy at a temperature close to room temperature. Low temperature heating systems or high temperature cooling systems that are suitable for office buildings, service buildings and residential buildings, can use a variety of fuels and renewable energy sources. These systems use energy efficiently while providing a comfortable indoor climate. They should be widely implemented now in order to create possibility to use sustainable energy sources in the near future.

The classical exergy analysis enables to pinpoint the location, to understand the cause, and to establish the true magnitude of waste and loss. Exergy analysis is therefore an important tool for the design of thermal systems since it provides the designer with additional information on where and why the losses occur. The designer can then proceed forward and work on how to improve the thermal system. Application of exergy analysis into buildings has not been usual before the implementation of Annex 37. Tools for exergy analysis of buildings were developed during the working time of Annex 37.

Exergy analysis can also be applied to human body to find optimal thermal conditions. Studies show that the lowest human body exergy consumption occurs at thermally neutral condition. Exergy consumption within the human body becomes higher in a cold environment due to larger difference in temperature between the human body and its surrounding space and also becomes higher in a hot environment mainly due to sweating. These findings suggest that heating and cooling systems may also work well in such conditions where the lowest amount of exergy is consumed by those systems. That is, we may be able to establish both thermal comfort and low-exergy consuming systems at the same time. The human body exergy analyses have now just started to articulate why LowEx systems are essential for creating rational and comfortable built environment.

There are currently many LowEx technologies available. Low temperature systems successfully combine both traditional and innovative new approaches to heating. Usually the heat is transferred into the room through air or liquid circulation systems and the same system can often be used for both heating and cooling.

Research shows that people living in houses with low temperature heating systems are very satisfied with ambient indoor air quality. In particular, thermal

comfort levels are considered to be higher than in houses with a traditional heating system. Residents also experienced a reduction in draughts and dust, and reported fresher air in houses with low temperature heating systems. The advantages and disadvantages, mentioned by the occupants in the survey conducted during Annex 37, are similar to results in the literature. Also experiences from the case studies supported the findings from literature and the occupants' survey.

By using low temperature heating systems the room temperature can be decreased by a few degrees, which is more energy efficient and healthier for occupants. Low temperature heating systems do not usually require radiators, which can be unsightly and hard to clean. This offers the additional advantages of increased living space and more flexibility in terms of interior design. Safety can also be improved during the heating season due to absence of hot radiator surfaces.

Low temperature heating systems are sustainable because they are flexible. These systems are not bound to any one energy source and fuel switching does not entail excessive cost. Low temperature systems can utilise a variety of sources of heat including district heat, biofuel, solar energy, gas, oil or electricity, and so the user is not constrained by choices made in the planning phase.

Thorough planning and expert implementation are prerequisites for an appropriate and functional system. System flexibility will be dependent on the choice of appliances and overall system design, which can be difficult and expensive to change after installation.

Low temperature heat distribution systems have an operating life of at least 30-40 years during which time the user benefits from the economic advantages offered by flexibility of fuel choice. The life cycle costs of a low temperature heating system are about the same as of a traditional system. Although the initial investment might be slightly higher, the system offers increased flexibility in terms of fuel choice and increased energy

efficiency. For example the efficiency of solar heating is considerably higher in a low temperature heating system than in a traditional one.

The demonstration projects of Annex 37 show the wide variety of possibilities to apply low exergy heating and cooling systems in buildings. There are examples of low exergy systems in dwellings and offices, but also in a museum and a concert hall.

The application of LowEx systems provides many additional benefits besides energy supply such as: improved thermal comfort, improved indoor air quality and

reduced energy consumption. These aspects should be further promoted to increase the application of LowEx systems for heating and cooling of buildings. The building regulations and energy strategies should take the quality of energy into account more than today.

Wide application of LowEx heating and cooling systems in buildings will create a building stock, which will be able to adapt to use of sustainable energy sources, when desired. Without this ability, the transfer towards an energy-wise sustainable world will be delayed for decades.

9. REFERENCES

Ahern, J. 1980. The exergy Method of Energy system Analysis. Wiley-Interscience Publication, John Wiley and Sons, New York.

Asada, H. and Shukuya, M. 1999. 'Numerical Analysis of Annual Exergy Consumption for Daylighting, Electric-Lighting, and Space Heating/Cooling System'. Sixth International IBPSA Conference (BS'99), Kyoto Japan, pp. 121-127.

Asada, H. and Takeda, H. 2002. 'Thermal environment and exergy analysis of a ceiling radiant cooling system, Proceedings of Sustainable Buildings 2002, International Conference, No. 561, Oslo, Norway, 23-25 September, 2002.

ASHRAE, 1997. Fundamentals, SI Edition, Energy Estimating and Modeling Methods. American Society of Heating, Refrigerating and Air-Conditioning Engineers, Inc. Atlanta, GA.

Baehr, H.D. 1980. Zur Thermodynamik des Heizens- I. Der zweite Hauptsatz und die konventionellen Heizsysteme. Brennstoff-Wärme-Kraft, Germany, Vol. 32, No. 1, pp. 9-15.

Cornelissen, R.L. 1997. Thermodynamics and Sustainable Development – The Use of Exergy Analysis and the Reduction of Irreversibilities. PhD Thesis. University of Twente, The Netherlands. ISBN 90 365 1053 8.

DIN 4701-10. 2001. Energy Efficiency of Heating and Ventilation Systems in Buildings – Part 10: Heating, Domestic hot Water, Ventilation. German national Standard. Berlin: Deutsches Institut für Normung e.V.

ECBCS 2002. Energy Conservation in Buildings and Community Service Programme. International Energy Agency. Web Homepage: <http://www.ecbcs.org>

Eijndems, H.H.E.W. and Boerstra, A.C. 1999. Kwalitatieve aspecten van lage temperatuur warmte-afgifte systemen. Cauberg-Huygen and BBA. Amsterdam, NL.

Eijndems, H.H.E.W., Op't Veld, P. and Boerstra, A.C. 2000. Literature review: Side effects of Low Exergy emission systems. Working report of Annex 37.

François, C., Hammache, A., Schmidt, D., Shukuya, M. and Zirngibl, J. 2004a. User-Guide for the Educational Tool for Energy and Exergy analyses of Heating and Cooling Applications in Buildings. Annex 37 working report.

François, C., Hammache, A., Schmidt, D., Shukuya, M. and Zirngibl, J. 2004b. User-Guide for the Pre-Design Tool for Energy and Exergy analyses of Heating and Cooling Applications in Buildings. Annex 37 working report.

Gertis, K. 1995. Realistische Betrachtung statt ideologischer Wünsche. Niedrigenergie- oder Niedrigentropiehäuser? Clima Commerce International CCI, Promoter Verlag Karlsruhe, Germany, Vol. 29, No 4, pp. 134-136.

Hammache, A. and Shukuya, M. 2004. Heating and cooling examples with the Pre-Design Tool for Energy and Exergy Analyses of Heating and Cooling Applications in Buildings. A case study with the pre-design tool developed for IEA ECBCS Annex 37.

Isawa K., Komizo T. and Shukuya M. 2002. Low Exergy Systems Will Provide us with the Lowest Human-Body Exergy Consumption and Thermal Comfort. LowEx News, publication of IEA Annex 37, No. 5; July 2002: pp 5-6.

Jenni, J. and Hawkins, A. 2002. Der Unterschied zwischen Temperatur und Energie – Oder was kann mit exergiegerechter Speicherladung und -entladung erreicht werden? Heizung-Klima, Switzerland, Vol. 29, No. 3, 2002, pp. 8-11.

Klemp, P. 1997. Exergetische Analyse unterschiedlicher Kälte- und Wärmebereitstellungsverfahren. Internal working report, Instiut für Angewandte Thermodynamik, University of Essen, Germany.

Maas, A., Hauser, G. and Höttges, K. 2002. Die Energieeinsparverordnung. Bauphysik, Publisher Ernst & Sohn, Germany, Vol. 24, No. 1, pp. 26-38.

Malovrh, M. and Praznik, M. 2002. Overview of knowledge on and experiences with low temperature heating in historical buildings in Slovenia. Paper presented in the LowExx workshop in Maastricht in March, 2002.

Moran, M.J. 1989. Availability Analysis – a Guide to Efficient Energy use. Corrected Edition. ASME Press, New York.

Moran, M.J. and Shapiro, H.N. 1998. Fundamentals of Engineering Thermodynamics. 3rd Edition, John Wiley & Sons, New York, USA.

Nishikawa, R. and Shukuya, M. 1999. 'Numerical Analysis on the Production of Cool Exergy by Making Use of Heat Capacity of Building Envelopes'. Sixth International IBPSA Conference (BS'99), Kyoto Japan, pp. 129-135.

Saito, M. and Shukuya, M. 2000. 'Exergy Balance of Human Body and Thermal Comfort'. Journal of Architectural Planning and Environmental Engineering, Architectural Institute of Japan, No. 535, pp. 17-23 (in Japanese with English abstract).

Saito, M., Isawa, K., Komizo, T. and Shukuya, M. 2002. "The Relationship Between Exergy Consumption Within the Human Body and Thermal Sensation - Part 2. Exergy consumption due to shivering and sweating, Annual Meeting of Architectural Institute of Japan, Building Science Section, pp. 573-574.

Schmidt, D. 2001. Models for Coupled Heat and Mass Transfer Processes in Buildings – Applications to Achieve Low Exergy Room Conditioning. Tekn. Lic. Thesis. ISRN KTH-BYT/R-01/185-SE, KTH. Stockholm, Sweden.

Schmidt, D. 2004. Design of Low Exergy Buildings - Method and a Pre-Design Tool. International Journal of Low Energy and Sustainable Buildings, Vol. 3, 2003.

Shukuya, M. and Hammache, A. 2002. Introduction to the concept of Exergy – for a better understanding of low-temperature-heating and high-temperature-cooling systems. Espoo: Technical Research Centre of Finland. 14 p. + app. 17 p. VTT Research Notes 2158, ISBN 951-38-6074-4.

Shukuya, M. 1994. 'Energy, Entropy, Exergy and Space Heating Systems', Proceedings of the 3rd International Conference "Healthy Buildings '94", Vol. 1, pp. 369-374.

Silvester, S., de Vries G. and Op't Veld, P. 2000. Occupants' experiences in dwellings with different LT heating systems. Internal report of IEA ECBCS Annex 37. 17 p.

Steimle, F. (ed.) 2000. Handbuch haustechnische Planung. Krämer Verlag, Stuttgart, Germany.

Wall, G. 1986. Exergy – a Useful Concept. PhD Thesis. Chalmers University of Technology Gothenburg, Sweden.

A. PARTICIPATING COUNTRIES

Central contacts for the participating countries are presented here. For an extended list of participants, see the CD-ROM version of the Guidebook.

OPERATING AGENT

Markku Virtanen

VTT Building and Transport
P.O. Box 1800
02044 VTT
Phone: +358 9 695 90 672
Mobile: +358 50 596 7690
Fax: +358 9 695 90 666
E-mail: markku.virtanen@take-finland.com

CANADA

Alain Legault

Natural Resources Canada
1615 Lionel-Boulet
Varenes Quebec J3X 1S6
Phone: +450-652-7031
Fax: +450-652-0999
E-mail: alain.legault@nrcan.gc.ca

DENMARK

Bjarne W. Olesen

International Centre for Indoor Environment
and Energy Technical University of Denmark
Department of Mechanical Engineering
Nils Koppels Allé, Building 402
DK-2800 Kgs. Lyngby
Phone: +45-45254117
Fax: +45-45932166
E-mail: bwo@mek.dtu.dk

FINLAND

Mia Ala-Juusela

VTT Building and Transport
P.O. Box 1800
FIN-02044 VTT
Phone: +358 9 456 6947
Fax: +358 9 455 2408
E-mail: mia.ala-juusela@vtt.fi

FRANCE

Johann Zirngibl

Centre Scientifique et Technique du
Bâtiment (CSTB)
84 avenue Jean Jaurès
Champs-sur-Marne BP 2
F-77421 Marne la Vallée Cedex 2,
Phone: +33 1 64 68 8312
Fax: +33 1 64 68 8350
E-mail: zirngibl@cstb.fr

GERMANY

Lars Kühl

TU Braunschweig
Mühlenpfordstr. 23
D-38106 Braunschweig
Phone: +49 531 391 3553
Fax: +49 531 391 8125
E-mail: kuehl@igs.bau.tu-bs.de

ITALY

Gaetano Fasano

ENEA- ENE
via Anguillarese, 301
00060 Rome
Phone: +39 06 3048 4827
Fax: +39 06 3048 3700
E-mail: gaetano.fasano@casaccia.enea.it

JAPAN

Masanori Shukuya

Musashi Institute of Technology
3-1, Ushikubo-Nishi 3-chome,
Tsuzuki-ku
Yokohama 224-0015
Phone: +81-45-910-2552
Fax: +81-45-910-2553
E-mail: shukuya@yc.musashi-tech.ac.jp

NETHERLANDS

Paul Ramsak

Novem
P.O. Box 17
6130 AA Sittard
Phone: +31 46 4202275
Fax: +31 46 4528260
E-mail: p.ramsak@novem.nl

NORWAY

Per Gundersen

Norwegian Building Research Institute
P.O. Box 123 Blindern
0314 Oslo
Phone: +47 22 965553
Fax: +47 22 965725
E-mail: per.gundersen@byggforsk.no

POLAND

Janusz Skorek

Division of Thermodynamics and Gas
Energy Institute of Thermal Technology
Technical University of Silesia
Konarskiego 22
44-100 Gliwice
Phone: +48 32 237-24-27
Fax: +48 32 237-28-72
E-mail: skorek@itc.ise.polsl.gliwice.pl

SWEDEN

Gudni Jóhannesson

KTH Building Technology
Brinellvägen 34
S-10044 Stockholm
Phone: +46 8 790 8670
Mobile: +46 70 595 3037
Fax: +46 8 411 8432
E-mail: gudni.johannesson@byv.kth.se

Dietrich Schmidt

KTH Building Technology
Brinellvägen 34
S-10044 Stockholm
Phone: +46 8 790 8716
Fax: +46 8 411 8432
E-mail: dietrich.schmidt@byv.kth.se

B. COMPANY AND PRODUCT INFORMATION

FINLAND		
<p>ARE Oy</p> 	<p>P.O.Box 160 FIN-001611 Vantaa Contact: Heikki Mäki. Email: heikki.maki@are.fi Phone: +358 20 530 5606 Fax: +358 20 530 5101 Web: http://www.are.fi</p>	<p>Business Area: ARE's business operations extend from designing to maintenance of building services. Main products: Building services systems.</p>
<p>Fläkt Woods</p> 	<p>P.O.Box 5 FIN-02621 Espoo Contact: Peter Sundelin Email: peter.sundelin@flaktwoods.com Phone: +358 20 4423000 Mobile: +358 40 8683299 Fax: +358 20 4423303</p>	<p>Business Area: A specialist in Air Climate and Air Ventilation, offering a comprehensive range of components, products and solutions. Fläkt Woods is a global ventilation pioneer and partner. Local presence in 95 countries. Main products: Ventilation products and services for Buildings and Industry.</p>
<p>Uponor Suomi Oy</p> 	<p>P.O.Box 21 FIN-15561 Nastola Contact: Jarmo Mäenpää. Email: jarmo.maenpaa@uponor.com Fax: +358 3 885 0270 Web: http://www.uponor.com</p>	<p>Business Area: Manufactures and markets a wide range of plastic pipe systems for potable water and gas distribution, for hot water distribution and heating as well as sewer systems for both municipal infrastructures and the house building sector. Main products: plastic pipes and systems used for underfloor heating, radiator connections and tap water installations in houses and buildings, pipe systems to municipalities, public utilities and state authorities for water supply, sewage, and storm water drainage, complete I systems in polyethylene, polypropylene or polyvinyl chloride for freshwater supply, soil and waste discharge, and cable protection.</p>

GERMANY

Uponor-Velta GmbH & Co. KG



Hans-Böckler-Ring 41
22851 Norderstedt
Phone: 0049 40 / 3 09 86-0
Fax: 0049 40 / 3 09 86-433
Web: <http://www.velta.de>

Business area: manufacturing, engineering company specialising in radiant heating and cooling systems. Main products: plastic pipes and systems used for underfloor / ceiling heating and cooling.

Zentrum für Umweltbewusstes Bauen e.V. (ZUB)



Gottschalkstrasse 28a
34127 Kassel
Contact: Jürgen Laudenbach
Phone: + 49 561 804 3189
Fax: + 49 561 804 3187
Web: www.zub-kassel.de

Business area: development and distribution of software tool and reserach projects in the field of energy efficient building, further education in the field of sustainable and energy efficient building
Main products: software and courses

JAPAN

PS Company, Ltd.



1-1-1 Tomigaya, Shibuya-ku, Tokyo,
151-0063, JAPAN
Contact: Dr. Yoshihisa Hirayama
Phone: +81-3-3485-8494
Fax: +81-3-3485-8779
E-mail: l-yoshi@psk.co.jp
Web: <http://www.ps-group.co.jp/>

Business area: manufacturing, engineering company specialising in radiant heating and cooling systems, humidification systems
Head Office: Tokyo
Office: Sapporo, Morioka, Sendai, Nagano, Niigata, Tokyo, Nagoya, Osaka, Fukuoka, and Kumamoto
Factory: Sapporo, Iwate, Tokyo
Main products: heating and cooling radiator systems, humidifiers, dehumidifiers

C. ADDITIONAL INFORMATION

On the CD-ROM version of the Guidebook you can find the following additional information.

BROCHURE

The Brochure "Low Temperature Heating Systems – Increased Energy Efficiency and Improved Comfort" gives an overview of the systems, some case examples and a short introduction of the LowEx project.

GUIDEBOOK AS PDF

A printable .pdf version of the Guidebook is available for those who prefer a paper version. The CD-ROM version, however, offers the user some additional opportunities in moving around in the Guidebook and includes some additional information.

SUMMARY REPORT AS PDF

The Summary Report introducing the Guidebook is available on the CD-ROM.

INTRODUCTION TO EXERGY

Shukuya, M. and Hammache, A. 2002. Introduction to the concept of Exergy – for a better understanding of low-temperature-heating and high-temperature-cooling systems, VTT Research Notes, **2158**, Technical Research Centre of Finland, Espoo.

This document was prepared during Annex 37. It describes the exergy concept, presents the basic principles of exergy analysis and gives examples of exergy calculation, especially in connection with heating and cooling systems of buildings.

LOWEX NEWS

The Annex 37 working group produced a newsletter twice yearly during the working phase of Annex 37. The first issue was published in September 2000 and last in December 2003. From the CD-ROM you can get the .pdf-versions of all the eight issues of LowEx News. A short description of the contents of each newsletter is provided on the CD-ROM.

LITERATURE REVIEW

Eijdem, H.H.E.W, Op't Veld, P. and Boerstra, A.C. 2000. Literature review: Side effects of Low Exergy emission systems. Working report of Annex 37.

In this study the characteristics of LTH emission systems are compared with those of a traditional system based on radiators or air heating with water at 90/70 °C. This comparison is used for assessing the merits of a low temperature heat source, with particular reference to thermal comfort, IAQ and energy performance.

OCCUPANTS' EXPERIENCES

Silvester, S., de Vries, G. and Op't Veld, P. 2000. Occupants' experiences in dwellings with different LT heating systems. Internal report of IEA ECBCS Annex 37. 17 pages.

The objective of the occupant survey was to make an inventory of the experiences of occupants with LT systems and to look if these systems fulfil the expectations of occupants.

CASE RELATED ARTICLES

Some LowEx case related articles are available at the CD-ROM for those, who are interested to learn more about the case buildings.

PUBLISHED ARTICLES

A list of the exergy related articles published by the members of Annex 37 working group is given on the CD-ROM. Some of the articles are even included in the CD-ROM.

TECHNICAL PRESENTATIONS

Technical presentations were prepared for the ECBCS ExCo meetings during the working time of Annex 37. Reports are available on the CD-ROM.

TOOLS

Both of the Exergy Analysis Tools described in Chapter 4 of the Guidebook are available on the CD-ROM.

TOOL MANUALS

User-Guides for both of the Exergy Analysis Tools described in Chapter 4 of the Guidebook are available on the CD-ROM.

LOWEXX

Selected documents from the LowExx project. There was a special project for LowEx systems in existing buildings. In this project the possibilities of LowEx systems in existing and historical buildings (LowExx) were investigated. Experiences from the Netherlands, Slovenia, Finland and Greece were brought together and discussed in a LowExx-workshop held in Maastricht, the Netherlands on March 2002.

LOWEXNET

The Annex 37 working group considered it very important to continue the working together to further promote the use of exergy concept in connection with buildings. The discussions during the Annex 37 Expert meeting in Kassel led to the founding of the International Society for Low Exergy Systems in Buildings (short LowExNet) on the 13th September 2003. The main objective of this network is to formulate our interest in the regarded topics beyond the working time of the IEA Annex 37 itself. It is planned to have workshops in connection with other international events. The first LowExNet Workshop was held in Rovaniemi, Finland in connection with the last Annex 37 meeting. It is planned to discuss new and also forgotten-ancient concepts, technologies and applications of LowEx systems. LowExNet will cover applications in countries outside the IEA, like those in Latin America and Africa. All information will be available on a website (<http://www.lowex.net/>).

D. PUBLISHED ARTICLES

A list of over forty exergy related publications by the members of the Annex 37 Working Group can be found in the Guidebook. Some articles are available on the CD-ROM.



IEA
Energy Conservation
in Buildings and
Community Systems
programme

LowEx, the international low temperature heating systems research programme, is part of the International Energy Agency's (IEA) Energy Conservation in Buildings and Community Systems programme (ECBCS). The aim of the programme was to promote rational use of energy by encouraging the use of low temperature heating systems and high temperature cooling systems of buildings.

LOWEX GUIDEBOOK

This Summary Report summarises and presents the contents of the Guidebook, which is included here in CD-ROM format.

The Guidebook is meant to help engineering offices, consultants and architects in their search for energy efficient heating and cooling systems that can provide the occupants with comfortable, clean and healthy environment. In addition, some background information is offered for real estate builders, building maintenance managers, political decision makers and the public at large. The Guidebook is available as a CD-rom version and also freely available on the internet (<http://www.lowex.net/>).

Exergy defines the quality of energy and is an important tool for designing and assessing different heating and cooling systems. In Annex 37, 'low exergy (LowEx) systems' are defined as heating or cooling systems that allow the use of low valued energy as the energy source. In practice, this means systems that provide heating or cooling energy at a temperature close to room temperature. Low temperature heating systems or high temperature cooling systems that are suitable for office buildings, service buildings and residential buildings, can use a variety of fuels and renewable energy sources. These systems use energy efficiently while providing a comfortable indoor climate. They should be widely implemented now in order to create possibility to use sustainable energy sources in the near future.

Tätä julkaisua myy
VTT TIETOPALVELU
PL 2000
02044 VTT
Puh. (09) 456 4404
Faksi (09) 456 4374

Denna publication säljs av
VTT INFORMATIONSTJÄNST
PB 2000
02044 VTT
Tel. (09) 456 4404
Fax (09) 456 4374

This publication is available from
VTT INFORMATION SERVICE
P.O.Box 2000
FIN-02044 VTT, Finland
Phone internat. 358 9 456 4404
Fax + 358 9 456 4374